

conedesign[®]

manipulační technika



Katalog 2010/1

**Rudle
kovové**



str. 05 - 19

**Kola bantamová
s duší**



str. 21 - 43

**Kolečka pojezdová,
pryžová, otočná**



str. 45 - 81

**Vozíky plošinové
a vozíky policové**



str. 83 - 93

**Zdvížené vozíky paletovací,
vysokozdvížené,
zvedací stoly**









str. 95 - 100

Ostatní výrobky



str. 103 - 113

	Rudle kovové	univerzální	250 - 500 kg	serie 12000	str. 05 - 08
	Rudle kovové	univerzální	150 - 300 kg	serie 12000	str. 09 - 12
	Rudle kovové	schodišťové	150 - 200 kg	serie 12000	str. 13
	Rudle kovové	na sudy	200 - 300 kg	serie 12000	str. 14
	Rudle kovové	na tlakové nádoby	100 - 250 kg	serie 12000	str. 15
	Rudle kovové	na pivo - limo	150 - 300 kg	serie 12000	str. 16
	Rudle kovové	speciální	200 - 250 kg	serie 12000	str. 17
	Rudle kovové	skládací	150 - 300 kg	serie 12000	str. 18
	Točny s koly	na schodišťové rudle	75 - 100 kg	serie 19000	str. 19
	Kola bantamová s duší		150 - 1600 kg	serie 3000	str. 21 - 34
	Kola bantamová s duší	otočná	120 - 200 kg	serie 16000	str. 35 - 37
	Kola bantamová s duší		70 - 180 kg	serie 4000	str. 38 - 40
	Kola bantamová s duší		180 - 250 kg	serie 3500	str. 41
	Kola	nafukovací s plastovou loukotí	50 kg	serie 3700	str. 42
	Kola	nafukovací s vypletenými ráfky	70 kg	serie 3600	str. 43
	Kolečka	pryžová	60 - 280 kg	serie 1000	str. 45 - 49
	Kolečka	pryžová	50 - 150 kg	serie 2000	str. 50 - 52
	Kolečka	s plastovou obručí	50 - 100 kg	serie 5000	str. 53
	Kolečka	pro nízkozdvížené a vysokozdvížené vozíky	400 - 2000 kg	serie 14000	str. 54 - 55
	Kolečka	otočná přístrojová	100 kg	serie 40000	str. 56 - 57
	Kolečka	otočná přístrojová	55 - 95 kg	serie 42000	str. 58
	Kolečka	otočná přístrojová	30 - 60 kg	serie 59000	str. 59
	Kolečka	otočná přístrojová	30 - 35 kg	serie 43000	str. 60
	Kolečka	nábytková	20 kg	serie 44000	str. 61
	Kolečka	otočná transportní	60 - 200 kg	serie 41000	str. 62
	Kolečka	otočná transportní	50 - 150 kg	serie 58000	str. 63
	Kolečka	otočná transportní	90 - 205 kg	serie 31000	str. 64 - 65
	Kolečka	otočná transportní	60 - 205 kg	serie 64000	str. 66
	Kolečka	otočná transportní	250 - 700 kg	serie 37000	str. 67 - 68
	Kolečka	otočná transportní	100 - 180 kg	serie 45000	str. 69 - 70
	Kolečka	otočná transportní	100 - 300 kg	serie 49000	str. 71 - 72
	Kolečka	otočná transportní	150 - 500 kg	serie 55000	str. 73
	Kolečka	otočná transportní	600 - 1800 kg	serie 35000	str. 74
	Kolečka	otočná transportní	800 - 3500 kg	serie 39000	str. 75
	Kolečka	otočná transportní	600 - 1200 kg	serie 48000	str. 76
	Kolečka	otočná transportní	100 - 250 kg	serie 47000	str. 77
	Kolečka	otočná transportní	100 kg	serie 46000	str. 78
	Kolečka	otočná transportní	350 - 600 kg	serie 33000	str. 79
	Kolečka	otočná transportní	100 - 180 kg	serie 50000	str. 79
	Kolečka	otočná pryžová	150 - 200 kg	serie 20000	str. 80
	Kolečka	otočná transportní	220 - 250 kg	serie 11500	str. 81
	Plošinové vozíky	modulární systém	240 - 600 kg	serie 52000	str. 83 - 86
	Plošinové vozíky	kovové	120 - 2400 kg	serie 51000	str. 87 - 90
	Policové vozíky	kovové	100 - 300 kg	serie 60000	str. 91 - 92
	Plošinové vozíky a rudle	hliníkové	90 - 120 kg	serie 53000, 26000	str. 93
	Nízkozdvížené vozíky		2000 - 3500 kg	serie 27000	str. 95
	Nízkozdvížené vozíky s váhou		2000 kg	serie 27600	str. 96
	Vysokozdvížené ruční vozíky		1000 - 1500 kg	serie 22000	str. 97
	Paletové nůžkové vozíky		1000 kg	serie 27500	str. 98
	Zdvížené stoly		150 - 500 kg	serie 29000	str. 99
	Zdvížené vozíky		250 - 500 kg	serie 29000 + typ 27070	str. 100
	Rukojeti plastové			serie 9000	str. 103 - 104
	Krytky nábojů kol	kovové, plastové		serie 10100, serie 10200	str. 105
	Zajišťovací kloboučky	kovové		serie 10000	str. 105
	Hustilky, spirálové hadice, foukací pistole			serie 99000	str. 106
	Upínače			serie 99100	str. 107
	Zahradní plečka			serie 91000	str. 108
	Nábojové nápravy			serie 89000	str. 109
	Kladky polyamidové			serie 87000, 97000	str. 110
	Válečky polyamidové			serie 83500, 83000	str. 111
	Kladky kovové			serie 95000	str. 112
	Kolečka litinová s nákolkem			serie 96000	str. 113

Vítejte v Domě koleček

Sortimentní katalog 2010/1, který právě držíte v ruce, Vás provede světem ruční manipulační techniky, kol a koleček.

Naleznete zde základní sortiment ručních vozíků - rudlů, bantamových kol s pneumatikami, širokou škálu kol, včetně otočných přístrojových a transportních, vozíky plošinové, policové a speciální. V oddělení zdvižných vozíků naleznete nabídku paletových nízkozdvižných vozíků, ručních vysokozdvižných vozíků a další sortiment. Poslední oddělení nabízí ostatní výrobky související s ruční manipulační technikou a nabízeným zbožím.

Pro správný výběr jakéhokoliv vozíku, kola a kolečka, je důležité stanovit účel a požadovanou nosnost. Uváděné nosnosti v tabulkách platí pro mezní zatížení vozíků, popřípadě pro statické zatížení kol a koleček. Pro výběr správného pojzdového kola nebo kolečka, je nutno uvažovat o dynamickém zatížení a působení dalších vlivů, jako je nerovnoměrné zatížení vozíku, spády, prahy apod. Správný výpočet uvažuje o koeficientu bezpečnosti $k=1,3 - 2$. V praxi se užívá tento výpočtový vzorec:

Stanovení požadované nosnosti kola :

$$\text{Nosnost kola} = \frac{\text{Vlastní hmotnost} + \text{max. hmotnost nákladu}}{\text{Počet kol}} \times k(\text{koeficient bezpečnosti})_{1,3 - 2}$$

Pro nafukovací kola se používá stejný výpočet nosnosti kola.

Pláště a duše kol jsou vyrobeny z pryže a jejich životnost je ovlivněna způsobem a četností používání a je časově omezena.

Ke všem nabízeným nafukovacím kolům uvedeným v tomto sortimentním katalogu nabízíme náhradní duše a náhradní pláště.

Pláště nebo i celá kola pro použití v náročných podmínkách je nutné dostatečně dimenzovat.

Nejste-li si jisti správným výběrem jakéhokoliv výrobku z našeho sortimentního katalogu, uveďte v objednávce druh zařízení nebo uvažovaný způsob použití. Pracovníci obchodního oddělení Vám rádi pomohou s výběrem.

conedesign[®]
manipulační technika



rudle kovové



1

2



3

4



5

6

1 Rudle 12001 PROFI lopata 500 x 150mm nosnost 250/300/350kg c

Rudl typ	Kolo Ø	Kolo typ	Provedení kol	Výška x šířka (mm)	Ložná plocha š x h (mm)	Hmotnost (kg)	Nosnost (kg)
12001.35	260	3021.22	kov.disk, GL, bantam s duší	1 140 x 680	500 x 150	13,20	300
12001.77	260	3021.03	kov. disk ,JL, bantam s duší	1 140 x 680	500 x 150	12	300
12001.13	260	4001.01	plast.disk, KL, bantam s duší	1 130 x 680	500 x 150	12	250
12001.30	300	4004.07	plast.disk, JL, bantam s duší	1 170 x 680	500 x 150	13	250
12001.12	300	3022.05	kov.disk, JL, bantam s duší	1 140 x 680	500 x 150	12,50	350

2 Rudle 12001 PROFI lopata 500 x 225 nosnost 300/400kg f

Rudl typ	Kolo Ø	Kolo typ	Provedení kol	Výška x šířka (mm)	Ložná plocha š x h (mm)	Hmotnost (kg)	Nosnost (kg)
12001.79	260	3021.03	kov.disk, JL, bantam s duší	1 140 x 680	500 x 225	13	300
12001.96	300	3022.05	kov.disk, JKL, bantam s duší	1 140 x 680	500 x 225	14	300
12001.60	260	3021.22	kov. disk, GL, bantam s duší	1140 x 680	500 x 225	13,60	300
12001.54	300	3018.09	kov. disk, JL, bantam s duší	1 140 x 680	500 x 225	15,50	400

3 Rudle 12001 PROFI lopata 500 x 290 nosnost 400/300kg b

Rudl typ	Kolo Ø	Kolo typ	Provedení kol	Výška x šířka (mm)	Ložná plocha š x h (mm)	Hmotnost (kg)	Nosnost (kg)
12001.04	300	3018.09	kov.disk, JL, bantam s duší	1 140 x 680	500 x 290	16,50	400
12001.42	300	3018.14	kov.disk, GL, bantam s duší	1 140 x 680	500 x 290	16,50	400
12001.78	260	3021.03	kov.disk, JL, bantam s duší	1 140 x 680	500 x 290	14	300

4 Rudle 12001.15 PROFI lopata 420 x 230mm nosnost 300kg g

Rudl typ	Kolo Ø	Kolo typ	Provedení kol	Výška x šířka (mm)	Ložná plocha š x h (mm)	Hmotnost (kg)	Nosnost (kg)
12001.15	260	3021.03	kov.disk, JL, bantam s duší	1 140 x 680	420 x 230	12,50	300

5 Rudle 12001 PROFI lopata 500 x 150mm nosnost 400kg a

Rudl typ	Kolo Ø	Kolo typ	Provedení kol	Výška x šířka (mm)	Ložná plocha š x h (mm)	Hmotnost (kg)	Nosnost (kg)
12001.41	300	3018.14	kov.disk, GL, bantam s duší	1 140 x 680	500 x 150	15	400
12001.83	300	3018.09	kov.disk, JL, bantam s duší	1 140 x 680	500 x 150	15	400

6 Rudle 12001.49 PROFI lopata 500 x 150mm nosnost 350kg c

Rudl typ	Kolo Ø	Kolo typ	Provedení kol	Výška x šířka (mm)	Ložná plocha š x h (mm)	Hmotnost (kg)	Nosnost (kg)
12001.49	300	1023.03	kov.disk, JL, pryžová obruč	1 180 x 520	500 x 150	18,50	350

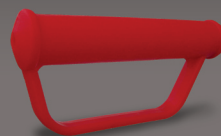

> univerzální



1



2



3



4



5



6

1 Rudl 12001 PROFI lopata 500 x 150/225/290 nosnost 250kg

Rudl typ	Kolo Ø	Kolo typ	Provedení kol	Výška x šířka (mm)	Ložná plocha š x h (mm)	Hmotnost (kg)	Nosnost (kg)
12001.06	250	1005.14	kov.disk, JL, pryžová obruč	1 140 x 680	500 x 150	16,10	250
12001.80	250	1005.14	kov.disk, JL, pryžová obruč	1 140 x 680	500 x 225	16,20	250
12001.75	250	1005.14	kov.disk, JL, pryžová obruč	1 140 x 680	500 x 290	16,90	250

2 Rudl 12011 PROFI lopata 500 x 150/225/290 mm nosnost 400 kg

Rudl typ	Kolo Ø	Kolo typ	Provedení kol	Výška x šířka (mm)	Ložná plocha š x h (mm)	Hmotnost (kg)	Nosnost (kg)
12011.02	300	3018.09	kov.disk, JL, bantam s duší	1 350 x 680	500 x 150	15	400
12011.17	300	3018.09	kov.disk, JL, bantam s duší	1 350 x 680	500 x 225	17	400
12011.18	300	3018.09	kov.disk, JL, bantam s duší	1 350 x 680	500 x 290	17,10	400
12011.06	300	3018.14	kov.disk, GL, bantam s duší	1 350 x 680	500 x 150	15,50	400
12011.20	300	3018.14	kov.disk, GL, bantam s duší	1 350 x 680	500 x 225	16	400
12011.19	300	3018.14	kov.disk, GL, bantam s duší	1 350 x 680	500 x 290	16,50	400

3 Rudl 12018 PROFI lopata 500 x 150mm nosnost 400kg

Rudl typ	Kolo Ø	Kolo typ	Provedení kol	Výška x šířka (mm)	Ložná plocha š x h (mm)	Hmotnost (kg)	Nosnost (kg)
12018.03	300	3018.14	kov.disk, GL, bantam s duší	1 140 x 680	500 x 150	16	400
12018.09	260	3014.12	kov.disk, JL, bantam s duší	1 160 x 540	500 x 150	14,70	400

4 Rudl 12024 PROFI lopata 500 x 150 mm nosnost 250/400kg

Rudl typ	Kolo Ø	Kolo typ	Provedení kol	Výška x šířka (mm)	Ložná plocha š x h (mm)	Hmotnost (kg)	Nosnost (kg)
12024.01	350	4013.01	plast disk, KL, bantam s duší	1 140 x 680	500 x 150	12,80	250
12024.06	350	3004.16	kov.disk, JL, bantam s duší	1 140 x 680	500 x 150	15,50	400
12024.07	350	3004.18	kov.disk, GL, bantam s duší	1 140 x 680	500 x 150	17	400

5 Rudl 12026 PROFI lopata 420 x 230mm nosnost 250/300kg

Rudl typ	Kolo Ø	Kolo typ	Provedení kol	Výška x šířka (mm)	Ložná plocha š x h (mm)	Hmotnost (kg)	Nosnost (kg)
12026.08	260	3021.22	kov.disk, GL, bantam s duší	1 120 x 570	420 x 230	12,80	300
12026.16	260	3021.03	kov.disk, JL, bantam s duší	1 120 x 570	420 x 230	12,50	300
12026.18	260	4001.01	plast.disk, KL, bantam s duší	1 120 x 570	420 x 230	11,90	250

6 Rudl 12049.04 PROFI lopata 500 x 290mm nosnost 250kg

Rudl typ	Kolo Ø	Kolo typ	Provedení kol	Výška x šířka (mm)	Ložná plocha š x h (mm)	Hmotnost (kg)	Nosnost (kg)
12049.04	260	3021.03	kov.disk, JL, bantam s duší	1 320 x 580	500 x 290	18,50	250

Ochranná lišta zadních lyžin k rudlům



Vozíky s koly o průměru 260 mm lze objednat s nepropíchnutelným bezúdržbovým kolem - více na str. 53



Zajišťovací kloboučky je možné objednávat samostatně na str. 105



Hustilky k nafukovacím kolům najdete na str. 106





1



2

1 Rudl 12055.03 PROFI lopata 500 x 290mm nosnost 250kg

Rudl typ	Kolo Ø	Kolo typ	Provedení kol	Výška x šířka (mm)	Ložná plocha š x h (mm)	Hmotnost (kg)	Nosnost (kg)
12055.03	260	3021.03	kov.disk, JL, bantam s duší	1 320 x 580	500 x 290	17,50	250

2 Rudl 12058.01 lopata 300 x 270 x 4mm nosnost 250kg

Rudl typ	Kolo Ø	Kolo typ	Provedení kol	Výška x šířka (mm)	Ložná plocha š x h (mm)	Hmotnost (kg)	Nosnost (kg)
12058.01	260	3021.03	kov.disk, JL, bantam s duší	1 320 x 570	300 x 270 x4	14,20	250

3 Rudl 12073 PROFI lopata 350 x 225mm nosnost 250kg

Rudl typ	Kolo Ø	Kolo typ	Provedení kol	Výška x šířka (mm)	Ložná plocha š x h (mm)	Hmotnost (kg)	Nosnost (kg)
12073.01	300	3022.05	kov.disk,JL, bantam s duší	1 300 x 630	350 x 225	17	250
12073.02	300	3018.15	kov.disk,GL, bantam s duší	1 300 x 630	350 x 225	16,50	250



3



4

4 Rudl 12077 PROFI lopata 420 x 230mm nosnost 300kg

Rudl typ	Kolo Ø	Kolo typ	Provedení kol	Výška x šířka (mm)	Ložná plocha š x h (mm)	Hmotnost (kg)	Nosnost (kg)
12077.01	260	3021.03	kov.disk,JL, bantam s duší	1 120 x 500	420 x 230	12,10	300
12077.02	260	3021.22	kov.disk,GL, bantam s duší	1 120 x 500	420 x 230	12,50	300



5



6

5 Rudl 12094 lopata 500 x 225mm nosnost 450/500kg

Rudl typ	Kolo Ø	Kolo typ	Provedení kol	Výška x šířka (mm)	Ložná plocha š x h (mm)	Hmotnost (kg)	Nosnost (kg)
12094.01	300	3018.14	kov.disk, GL, bantam s duší	1 170 x 620	500 x 225	19,10	450
12094.02	300	3018.09	kov.disk, JL, bantam s duší	1 170 x 620	500 x 225	19	450
12094.03	300	3018.22	kov.disk, GL, bantam s duší	1 170 x 620	500 x 225	20	500

6 Rudl 12096 PROFI lopata 500 x 150mm nosnost 300/350kg

Rudl typ	Kolo Ø	Kolo typ	Provedení kol	Výška x šířka (mm)	Ložná plocha š x h (mm)	Hmotnost (kg)	Nosnost (kg)
12096.01	260	3021.03	kov.disk,JL, bantam s duší	1 158 x 680	500 x 150	12,40	300
12096.02	300	3022.05	kov.disk,JL, bantam s duší	1 160 x 680	500 x 150	13,20	350

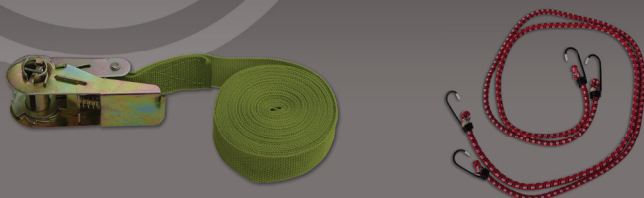

> univerzální



Rudl 12118.01 PROFI zinek lopata 500 x 150mm nosnost 400kg

Rudl typ	Kolo Ø	Kolo typ	Provedení kol	Výška x šířka (mm)	Ložná plocha š x h (mm)	Hmotnost (kg)	Nosnost (kg)
12118.01	300	3018.11	kov.disk, JL, bantam s duší	1 180 x 660	500 x 150	12,50	400



Rudl 12126.16 PROFI zinek lopata 420 x 230mm nosnost 300kg

Rudl typ	Kolo Ø	Kolo typ	Provedení kol	Výška x šířka (mm)	Ložná plocha š x h (mm)	Hmotnost (kg)	Nosnost (kg)
12126.16	260	3021.03	kov.disk, JL, bantam s duší	1 120 x 570	420 x 230	12,50	300



Rudl 12301 lopata 500 x 225mm nosnost 300/400kg

Rudl typ	Kolo Ø	Kolo typ	Provedení kol	Výška x šířka (mm)	Ložná plocha š x h (mm)	Hmotnost (kg)	Nosnost (kg)
12301.01	260	3021.03	kov.disk, JL, bantam s duší	1 365 x 680	500 x 225	16,70	300
12301.02	300	3018.11	kov.disk, JL, bantam s duší	1 370 x 680	500 x 225	17,90	400

Ochranná lišta zadních lyžin k rudlům



Vozíky s koly o průměru 260 mm lze objednat s nepropíchnutelným bezúdržbovým kolem - více na str. 53



Zajišťovací kloboučky je možné objednávat samostatně na str. 105



Hustilky k nafukovacím kolům najdete na str. 106



> univerzální



1

2

1 Rudl 12002 lopata 400 x 230mm nosnost 200kg

Rudl typ	Kolo Ø	Kolo typ	Provedení kol	Výška x šířka (mm)	Ložná plocha š x h (mm)	Hmotnost (kg)	Nosnost (kg)
12002.17	200	41200.01	kov.disk, JL, pryžová obruč	1 060 x 480	400 x 230	10,50	200
12002.23	200	2008.08	plast.disk, KL, pryžová obruč	1 060 x 480	400 x 230	9,50	200

2 Rudl 12002 lopata 400 x 230mm nosnost 200kg

Rudl typ	Kolo Ø	Kolo typ	Provedení kol	Výška x šířka (mm)	Ložná plocha š x h (mm)	Hmotnost (kg)	Nosnost (kg)
12002.25	200	4030.02	plast.disk, JL, bantam s duší	1 060 x 480	400 x 230	8	200
12002.26	210	4006.01	plast.disk, JL, bantam s duší	1 060 x 480	400 x 230	7,90	200



3

4

3 Rudl 12012 lopata 400x170 nosnost 200kg

Rudl typ	Kolo Ø	Kolo typ	Provedení kol	Výška x šířka (mm)	Ložná plocha š x h (mm)	Hmotnost (kg)	Nosnost (kg)
12012.01	260	4001.01	plast.disk, KL, bantam s duší	1 060 x 520	400 x 170	8	200
12012.10	260	3021.03	kov.disk, JL, bantam s duší	1 060 x 520	400 x 170	8,50	200

4 Rudl 12014 lopata 400 x 170mm nosnost 200/250kg

Rudl typ	Kolo Ø	Kolo typ	Provedení kol	Výška x šířka (mm)	Ložná plocha š x h (mm)	Hmotnost (kg)	Nosnost (kg)
12014.01	260	4001.01	plast.disk, KL, bantam s duší	1 100 x 540	400 x 170 /200	9,10	200
12014.11	260	3021.03	kov.disk, JL, bantam s duší	1 100 x 540	400 x 170 /200	9,50	250
12014.13	250	1005,14	kov.disk, JL, pryžová obruč	1 100 x 540	400 x 170 /200	12,20	200

5 Rudl 12019 lopata 400 x 170mm nosnost 200kg

Rudl typ	Kolo Ø	Kolo typ	Provedení kol	Výška x šířka (mm)	Ložná plocha š x h (mm)	Hmotnost (kg)	Nosnost (kg)
12019.01	260	4001.01	plast.disk, KL, bantam s duší	1 060 x 520	400 x 170	8	200
12019.11	260	3021.03	kov.disk, JL, bantam s duší	1 060 x 520	400 x 170	9	200



5

6

6 Rudl 12027 lopata 350 x 175mm nosnost 250kg

Rudl typ	Kolo Ø	Kolo typ	Provedení kol	Výška x šířka (mm)	Ložná plocha š x h (mm)	Hmotnost (kg)	Nosnost (kg)
12027.01	260	4001.01	plast.disk, KL, bantam s duší	1 300 x 550	350 x 175	11,50	250
12027.10	260	3021.03	kov.disk, JL, bantam s duší	1 300 x 550	350 x 175	11	250



> univerzální



1



2

1 Rudl 12029.11 lopata 400 x 150mm nosnost 250 kg

Rudl typ	Kolo Ø	Kolo typ	Provedení kol	Výška x šířka (mm)	Ložná plocha š x h (mm)	Hmotnost (kg)	Nosnost (kg)
12029.11	260	3021.03	kov.disk, JL, bantam s duší	1 170 x 560	400 x 150	11	250

2 Rudl 12030 lopata 400 x 170mm nosnost 200 kg

Rudl typ	Kolo Ø	Kolo typ	Provedení kol	Výška x šířka (mm)	Ložná plocha š x h (mm)	Hmotnost (kg)	Nosnost (kg)
12030.01	260	4001.01	plast.disk, KL, bantam s duší	1 010 x 500	400 x 170	9,50	200
12030.11	260	3021.03	kov.disk, JL, bantam s duší	1 010 x 500	400 x 170	11	200



3



4

3 Rudl 12033.01 lopata 400 x 170mm nosnost 200kg

Rudl typ	Kolo Ø	Kolo typ	Provedení kol	Výška x šířka (mm)	Ložná plocha š x h (mm)	Hmotnost (kg)	Nosnost (kg)
12033.01	260	4001.01	plast.disk, KL, bantam s duší	1 190 x 590	400 x 170	9,50	200

4 Rudl 12038 lopata 370 x 232mm nosnost 250/200kg

Rudl typ	Kolo Ø	Kolo typ	Provedení kol	Výška x šířka (mm)	Ložná plocha š x h (mm)	Hmotnost (kg)	Nosnost (kg)
12038.01	260	3021.03	kov.disk, JL, bantam s duší	1 300 x 545	370 x 232	13,50	250
12038.03	250	1005.14	kov.disk, JL, pryžová obruč	1 300 x 545	370 x 232	13,60	200



5



6

5 Rudl 12064.01 lopata 400 x 170mm nosnost 200kg

Rudl typ	Kolo Ø	Kolo typ	Provedení kol	Výška x šířka (mm)	Ložná plocha š x h (mm)	Hmotnost (kg)	Nosnost (kg)
12064.01	260	4001.01	plast.disk, KL, bantam s duší	1 120 x 570	400 x 170	8	200

6 Rudl 12085.01 se sítí, lopata 400 x 220mm nosnost 200kg

Rudl typ	Kolo Ø	Kolo typ	Provedení kol	Výška x šířka (mm)	Ložná plocha š x h (mm)	Hmotnost (kg)	Nosnost (kg)
12085.01	200	2008.08	plast.disk, KL, pryžová obruč	1 070 x 510	400 x 220	9,50	200

Vozíky s koly o průměru 260 mm lze objednat s nepropíchnutelným bezúdržbovým kolem - více na str. 53

Zajišťovací kloboučky je možné objednávat samostatně na str. 105

Hustilky k nafukovacím kolům najdete na str. 106





1



2

1 Rudl 12086 MINI lopata 350 x 100mm nosnost 150 kg

Rudl typ	Kolo Ø	Kolo typ	Provedení kol	Výška x šířka (mm)	Ložná plocha š x h (mm)	Hmotnost (kg)	Nosnost (kg)
12086.01	210	3023.03	kov.disk, JL, bantam s duší	810 x 495	350 x 100	5	150
12086.02	210	4005.01	plast.disk, KL, bantam s duší	810 x 495	350 x 100	5	150

2 Rudl 12095 lopata 400 x 170mm nosnost 200/250kg

Rudl typ	Kolo Ø	Kolo typ	Provedení kol	Výška x šířka (mm)	Ložná plocha š x h (mm)	Hmotnost (kg)	Nosnost (kg)
12095.01	260	4001.01	plast.disk, KL, bantam s duší	1 070 x 620	400 x 170	9,20	200
12095.02	260	3021.03	kov.disk, JL, bantam s duší	1 070 x 620	400 x 170	9,50	250



3



4

3 Rudl 12095.03 lopata 400 x 170mm nosnost 250kg

Rudl typ	Kolo Ø	Kolo typ	Provedení kol	Výška x šířka (mm)	Ložná plocha š x h (mm)	Hmotnost (kg)	Nosnost (kg)
12095.03	260	3021.03	kov.disk, JL, bantam s duší	1 070 x 610	400 x 170	9,50	250

4 Rudl 12098.01 lopata 400 x 190mm nosnost 250kg

Rudl typ	Kolo Ø	Kolo typ	Provedení kol	Výška x šířka (mm)	Ložná plocha š x h (mm)	Hmotnost (kg)	Nosnost (kg)
12098.01	260	3021.03	kov.disk, JL, bantam s duší	1 320 x 600	400 x 190	14,40	250



5



6

5 Rudl 12099.01 lopata 340 x 150mm nosnost 200kg

Rudl typ	Kolo Ø	Kolo typ	Provedení kol	Výška x šířka (mm)	Ložná plocha š x h (mm)	Hmotnost (kg)	Nosnost (kg)
12099.01	200	2008.08	plast.disk, KL, pryžová obruč	1 123 x 470	340 x 150	15,20	200

6 Rudl 12125.11 lopata 300 x 220mm nosnost 250kg

Rudl typ	Kolo Ø	Kolo typ	Provedení kol	Výška x šířka (mm)	Ložná plocha š x h (mm)	Hmotnost (kg)	Nosnost (kg)
12125.11	260	3021.03	kov.disk, JL, bantam s duší	1 250 x 550	300 x 220	12,20	250

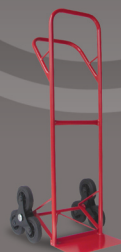

> univerzální



Rudl 12302.01 lopata 340x155mm nosnost 250kg

Rudl typ	Kolo Ø	Kolo typ	Provedení kol	Výška x šířka (mm)	Ložná plocha š x h (mm)	Hmotnost (kg)	Nosnost (kg)
12302.01	260	3021.03	kov.disk, JL, bantam s duší	1 100 (1375) x 540	340 x 155	18,00	250



Rudl 12303.01 lopata 340 x 155mm nosnost 300kg

Rudl typ	Kolo Ø	Kolo typ	Provedení kol	Výška x šířka (mm)	Ložná plocha š x h (mm)	Hmotnost (kg)	Nosnost (kg)
12303.01	260	3021.03	kov.disk, JL, bantam s duší	1 110 x 530	340 x 155	14,70	300



Rudl 12009.10 lopata 350 x 185 mm nosnost 200kg

Rudl typ	Kolo Ø	Kolo typ	Provedení kol	Výška x šířka (mm)	Ložná plocha š x h (mm)	Hmotnost (kg)	Nosnost (kg)
12009.10	260	3021.03	kov.disk, JL, bantam s duší	1120 x 545	350 x 185	9,00	200

Ochranná lišta zadních lyžin k rudlům



Vozíky s koly o průměru 260 mm lze objednat s nepropíchnutelným bezúdržbovým kolem - více na str. 53



Zajišťovací kloboučky je možné objednávat samostatně na str. 105



Hustilky k nafukovacím kolům najdete na str. 106



> schodišťové



1

2

1 Rudl 12023.12 lopata 350 x 175mm nosnost 150kg

Rudl typ	Kolo Ø	Točna typ	Provedení kol	Výška x šířka (mm)	Ložná plocha š x h (mm)	Hmotnost (kg)	Nosnost (kg)
12023.12	140	19102.17 s koly 2006.03	plast.disk, KL, pryžová obruč	1300 x 510	350 x 175	14	150

2 Rudl 12048.04 lopata 340 x 386mm nosnost 150kg

Rudl typ	Kolo Ø	Točna typ	Provedení kol	Výška x šířka (mm)	Ložná plocha š x h (mm)	Hmotnost (kg)	Nosnost (kg)
12048.04	160	19102.19 s koly 41160.01	kov.disk, JL, pryžová obruč	1230 x 620	340 x 386	20	150



3

3 Rudl 12081 PROFI lopata 400 x 205mm nosnost 150/200kg s aretací

Rudl typ	Kolo Ø	Točna typ	Provedení kol	Výška x šířka (mm)	Ložná plocha š x h (mm)	Hmotnost (kg)	Nosnost (kg)
12081.01	200	19102.23 s koly 2008.08	plast.disk, KL, pryžová obruč	1320 x 575	400 x 205	22,45	150
12081.02	200	19102.21 s koly 4030.02	plast.disk, JL, bantam s duší	1320 x 575	400 x 205	20,50	150
12081.11	160	19102.19 s koly 41160.01	kov.disk, JL, pryžová obruč	1320 x 560	400 x 205	21,10	200

4 Rudl 12089.01 lopata 410 x 175mm nosnost 200kg

Rudl typ	Kolo Ø	Točna typ	Provedení kol	Výška x šířka (mm)	Ložná plocha š x h (mm)	Hmotnost (kg)	Nosnost (kg)
12089.01	140	19102.17 s koly 2006.03	plast.disk, KL, pryžová obruč	1138 x 540	410 x 175	19	200



4

5

5 Rudl 12093 lopata 340 x 470mm nosnost 150kg

Rudl typ	Kolo Ø	Točna typ	Provedení kol	Výška x šířka (mm)	Ložná plocha š x h (mm)	Hmotnost (kg)	Nosnost (kg)
12093.01	200	19102.21 s koly 4030.02	plast.disk, JL, bantam s duší	1300 x 590	340 x 470	20,70	150
12093.02	200	19102.23 s koly 2008.08	plast.disk, KL, bantam s duší	1300 x 590	340 x 470	21,60	150



> na sudy



1

2

1 Rudl 12016 PROFI nosnost 250kg

Rudl typ	Kolo Ø	Kolo typ	Provedení kol	Výška x šířka (mm)	Ložná plocha š x h (mm)	Hmotnost (kg)	Nosnost (kg)
12016.10	260	3021.03	kov.disk, JL, bantam s duší	1290 x 690	speciální pro sud 200l kov	13	250
12016.11	250	1005.14	kov.disk, JL, pryžová obruč	1290 x 690	speciální pro sud 200l kov	13,50	250

2 Rudl 12044.01 nosnost 200kg

Rudl typ	Kolo Ø	Kolo typ	Provedení kol	Výška x šířka (mm)	Ložná plocha š x h (mm)	Hmotnost (kg)	Nosnost (kg)
12044.01	200	2008.08 2x 58200,070BIL1x 83055,98 SGL4x	kov.disk, KL, bantam s duší	1920 x 590	speciální pro sud 200l kov	21	200



3

4

3 Rudl 12045.01 PROFI nosnost 250kg

Rudl typ	Kolo Ø	Kolo typ	Provedení kol	Výška x šířka (mm)	Ložná plocha š x h (mm)	Hmotnost (kg)	Nosnost (kg)
12045.01	260 200	2x1005.14 1x31200.050KL	kov.disk, JL, pryžová obruč kov.disk, KL, pryžová obruč	1290 x 680	kov. sud 200l	19	250

4 Rudl 12071.01 PROFI nosnost 250kg

Rudl typ	Kolo Ø	Kolo typ	Provedení kol	Výška x šířka (mm)	Ložná plocha š x h (mm)	Hmotnost (kg)	Nosnost (kg)
12071.01	250 200	1005.14 2008.08	pryž.kov.disk JL pryž.plast. disk KL	1070 x 600 x 1600 hl.	speciální pro sud 200l	24,30	250



5

6

5 Rudl 12092.01 nosnost 300kg

Rudl typ	Kolo Ø	Kolo typ	Provedení kol	Výška x šířka (mm)	Ložná plocha š x h (mm)	Hmotnost (kg)	Nosnost (kg)
12092.01	200	kolo 200KL2x 1000BK1x	plast.disk, KL, Pu, pryž	1000 x 900	pro 200l sud	40	300

6 Rudl 12059.02 nosnost 250kg

Rudl typ	Kolo Ø	Kolo typ	Provedení kol	Výška x šířka (mm)	Ložná plocha š x h (mm)	Hmotnost (kg)	Nosnost (kg)
12059.02	270	3026.06	kov.disk, JL bantam s duší	1240 x 500	325 x 200	14	250

Vozíky s koly o průměru 260 mm lze objednat s nepropíchnutelným bezúdržbovým kolem - více na str. 53

Zajišťovací kloboučky je možné objednávat samostatně na str. 105

Hustilky k nafukovacím kolům najdete na str. 106





1

2



3

4



5

6

1 Rudl 12003, 12013 nosnost 150kg

Rudl typ	Kolo Ø	Kolo typ	Provedení kol	Výška x šířka (mm)	Ložná plocha š x h (mm)	Hmotnost (kg)	Nosnost (kg)
12013.01	200	41200.01	kov.disk, JL, pryžová obruč	1 160 x 400	pro kruh. nádobu prům.300mm	9	150
12013.04	200	2008.08	plast.disk, KL, pryžová obruč	1 160 x 400	pro kruh. nádobu prům.300mm	9,50	150
12003.01	200	41200.01	kov.disk, JL, pryžová obruč	1 160 x 400	pro kruh. nádobu prům.200mm	8,50	150
12003.05	200	2008.08	plast.disk, KL, pryžová obruč	1 160 x 400	pro kruh. nádobu prům.200mm	9,80	150

2 Rudl 12032 PROFI nosnost 250 kg

Rudl typ	Kolo Ø	Kolo typ	Provedení kol	Výška x šířka (mm)	Ložná plocha š x h (mm)	Hmotnost (kg)	Nosnost (kg)
12032.03	400	1019.03	kov.disk, JL, pryžová obruč	1 225 x 750 x 1660	speciální rudl pro tlakové lahve	29	250
12032.04	400	1019.12	kov.disk, GL, pryžová obruč	1 225 x 750 x 1660	speciální rudl pro tlakové lahve	29,20	250

3 Rudl 12067.01 PROFI nosnost 250kg

Rudl typ	Kolo Ø	Kolo typ	Provedení kol	Výška x šířka (mm)	Ložná plocha š x h (mm)	Hmotnost (kg)	Nosnost (kg)
12067.01	400	1019.03	kov.disk, JL, pryžová obruč	1400 x 660	svář. soupr.	22	250

4 Rudl 12070.01 nosnost 100kg

Rudl typ	Kolo Ø	Kolo typ	Provedení kol	Výška x šířka (mm)	Ložná plocha š x h (mm)	Hmotnost (kg)	Nosnost (kg)
12070.01	200	2008.08	plast.disk, KL, pryžová obruč	1100 x 430	láhev PB prům. 300	6,70	100

5 Rudl 12072.01 nosnost 250kg

Rudl typ	Kolo Ø	Kolo typ	Provedení kol	Výška x šířka (mm)	Ložná plocha š x h (mm)	Hmotnost (kg)	Nosnost (kg)
12072.01	400	1019.03	kov.disk, JL, pryžová obruč	1310 x 560	spec. pro tl. nádobu	26	250

6 Rudl 12076 nosnost 150kg

Rudl typ	Kolo Ø	Kolo typ	Provedení kol	Výška x šířka (mm)	Ložná plocha š x h (mm)	Hmotnost (kg)	Nosnost (kg)
12076.01	210	3023.03	kov.disk, JL, bantam s duší	1 220 x 460	pro tlak. nádobu prům. 200, 220mm	7	150
12076.02	200	41200.01	kov.disk, JL, pryžová obruč	1 220 x 460	pro tlak. nádobu prům. 200, 220mm	8,50	150



> na pivo - limo



1

2

1 Rudl 12069 PROFI lopata 400 x 210mm nosnost 200kg

Rudl typ	Kolo Ø	Kolo typ	Provedení kol	Výška x šířka (mm)	Ložná plocha š x h (mm)	Hmotnost (kg)	Nosnost (kg)
12069.03	300	3022.05	kov.disk, JL, bantam s duší	1 320 x 500	400 x 210	16	200
12069.04	300	3018.15	kov.disk, GL, bantam s duší	1 320 x 500	400 x 210	16	200



3

4

2 Rudl 12040 lopata 300 x 193mm nosnost 200kg

Rudl typ	Kolo Ø	Kolo typ	Provedení kol	Výška x šířka (mm)	Ložná plocha š x h (mm)	Hmotnost (kg)	Nosnost (kg)
12040.04	260	3021.03	kov.disk, JL, bantam s duší	1 240 x 524	300 x 193	12,50	200
12040.07	260	3021.22	kov.disk, GL, bantam s duší	1 240 x 524	300 x 193	12,50	200

3 Rudl 12074 lopata 410 x 245/270mm nosnost 200kg

Rudl typ	Kolo Ø	Kolo typ	Provedení kol	Výška x šířka (mm)	Ložná plocha š x h (mm)	Hmotnost (kg)	Nosnost (kg)
12074.01	260	3021.03	kov.disk, JL, bantam s duší	1 300 x 540	410 x 245	12,50	200
12074.03	260	3021.03	kov.disk, JL, bantam s duší	1 300 x 540	410 x 270	12,80	200

4 Rudl 12097.01 lopata 410 x 175mm nosnost 200kg

Rudl typ	Kolo Ø	Kolo typ	Provedení kol	Výška x šířka (mm)	Ložná plocha š x h (mm)	Hmotnost (kg)	Nosnost (kg)
12097.01	260	3021.03	kov.disk, JL, bantam s duší	1 130 x 540	410 x 175	11,80	200



5

6

5 Rudl 12031 lopata 280 x 230mm nosnost 250kg

Rudl typ	Kolo Ø	Kolo typ	Provedení kol	Výška x šířka (mm)	Ložná plocha š x h (mm)	Hmotnost (kg)	Nosnost (kg)
12031.01	260	4001.01	plast.disk, KL, bantam s duší	1 300 x 500	280 x 230	11,50	250
12031.07	260	3021.03	kov.disk, JL, bantam s duší	1 300 x 500	280 x 230	12	250

6 Rudl 12075 PROFI lopata 350 x 70mm nosnost 200kg

Rudl typ	Kolo Ø	Kolo typ	Provedení kol	Výška x šířka (mm)	Ložná plocha š x h (mm)	Hmotnost (kg)	Nosnost (kg)
12075.01	260	3021.22	kov.disk, GL, bantam s duší	1 300 x 420	350 x 70 (120)	12	200
12075.02	260	3021.03	kov.disk, JL, bantam s duší	1 300 x 420	350 x 70 (120)	12	200

Ochranná lišta zadních lyžin k rudlům



Vozíky s koly o průměru 260 mm lze objednat s nepropíchnutelným bezúdržbovým kolem - více na str. 53



Zajišťovací kloboučky je možné objednávat samostatně na str. 105



Hustilky k nafukovacím kolům najdete na str. 106





1



2



3



4



5

1 Rudl 12007 nosnost 200/150kg

Rudl typ	Kolo Ø	Kolo typ	Provedení kol	Výška x šířka (mm)	Hmotnost (kg)	Nosnost (kg)
12007.02	200	41200.01	kov.disk, JL, pryžová obruč	1 120 x 430	6,50	200
12007.05	200	2008.08	plast.disk, KL, pryžová obruč	1 120 x 430	6,00	150

2 Zdvíhací paletový vozík (rudle) na krby - serie 27070.00

Celková šířka (mm)	656	Výška celkem (mm)	1091
Šířka lyžiny (mm)	100	Délka celkem (mm)	817
Délka lyžiny (mm)	625	Nosnost (kg)	250
Zdvih (mm)	760	Hmotnost (kg)	53
Úhel natáčení	-	Rozměr kola - přední	50 OKL
Výška lyžin MIN (mm)	70	Rozměr kola - zadní	160
Výška lyžin MAX (mm)	760		

3 Rudl 12010.08 sklopná + pevná lopata nosnost 250kg

Rudl typ	Kolo Ø	Kolo typ	Provedení kol	Výška x šířka (mm)	Ložná plocha š x h (mm)	Hmotnost (kg)	Nosnost (kg)
12010.08	260	3021.03	kov.disk, JL, bantam s duší	1 110 x 540	pl. 350x140 tr. 380x430	15,50	250

4 Rudl 12068.01 sklopná + pevná lopata nosnost 200kg

Rudl typ	Kolo Ø	Kolo typ	Provedení kol	Výška x šířka (mm)	Ložná plocha š x h (mm)	Hmotnost (kg)	Nosnost (kg)
12068.01	300	3022.05	kov.disk, JL, bantam s duší	1 230 x 590	pl. 400x170 tr. 350x620	16,50	200

5 Rudl 12304.01 lopata 400x175/400mm nosnost 150kg

Rudl typ	Kolo Ø	Kolo typ	Provedení kol	Výška x šířka (mm)	Ložná plocha š x h (mm)	Hmotnost (kg)	Nosnost (kg)
12304.01	300	3018.09	kov.disk, JL, bantam s duší	1 300 x 630 x 830	400 x 175 (400 x 440)	17,70	150



> skládací



Rudl 12041 lopata 360 x 155mm nosnost 150kg

Rudl typ	Kolo Ø	Kolo typ	Provedení kol	Výška x šířka (mm)	Ložná plocha š x h (mm)	Hmotnost (kg)	Nosnost (kg)
12041.03	260	2x4001.01	plast.disk, KL, bantam s duší	1 205 x 525 x 1060	360 x 155 (940 x 360)*	16,50	150
	125	2x42125.21	plast.disk,kov.konzola,KL,pryž.obruč.				
12041.04	260	2 x3021.03	kov.disk, JL, bantam s duší	1 205 x 525 x 1060	360 x 155 (940 x 360)*	16,80	150
		2x42155.21	plast.disk,kov.konzola,KL,pryž.obruč.				

*Údaje v závorce platí pro ložnou plochu plošinového vozíku.

Rudl 12079.01 lopata 270 x 200mm nosnost 170kg

Rudl typ	Kolo Ø	Kolo typ	Provedení kol	Výška x šířka (mm)	Ložná plocha š x h (mm)	Hmotnost (kg)	Nosnost (kg)
12079.01	270	-	kov.disk, GL, bantam s duší	1180 x 530	270 x 200	10,50	170

Rudl 12090.02 lopata 410 x 270mm nosnost 300kg

Rudl typ	Kolo Ø	Kolo typ	Provedení kol	Výška x šířka (mm)	Ložná plocha š x h (mm)	Hmotnost (kg)	Nosnost (kg)
12090.02	260	3026.05	kov.disk,JL, bantam s duší	1 260 x 600 x 520	410 x 270 (410 x 610)	19,40	300

Rudl 12091.01 lopata 410x270mm nosnost 300kg

Rudl typ	Kolo Ø	Kolo typ	Provedení kol	Výška x šířka (mm)	Ložná plocha š x h (mm)	Hmotnost (kg)	Nosnost (kg)
12091.01	260	2 x3021.03	kov.disk, JL, bantam s duší	1 260 x 600 x 520	410 x 270 (410 x 610)	25	300
	100	2x42100.21	plast.disk,kov.konzola,KL,pryž.obruč.		(410 x 1060)		

Vozíky s koly o průměru 260 mm lze objednat s nepropíchnutelným bezúdržbovým kolem - více na str. 53

Zajišťovací kloboučky je možné objednávat samostatně na str. 105

Hustilky k nafukovacím kolům najdete na str. 106











Točna 19102.17

Točna typ	 mm	 mm	Kolo typ		 mm	 mm	 kg	 kg
19102.17	140	30	2006.03	KL	20	55	2,18	75









Točna 19102.19

Točna typ	 mm	 mm	Kolo typ		 mm	 mm	 kg	 kg
19102.21	160	30	41160.01	JL	20	70	3,80	100









Točna 19102.21

Točna typ	 mm	 mm	Kolo typ		 mm	 mm	 kg	 kg
19102.21	200	50	4030.02	JL	20	70	3,70	100



Točna 19102.22

Točna typ	 mm	 mm	Kolo typ		 mm	 mm	 kg	 kg
19102.22	200	40	41200.01	JL	20	70	5,60	100



Točna 19102.23

Točna typ	 mm	 mm	Kolo typ		 mm	 mm	 kg	 kg
19102.23	200	45	2008.08	KL	20	70	3,90	100





**kola bantamová
s duší**



Kolečka bantamová s duší 2.50-4, 3.00-4 150kg serie 3000

typ	mm	mm	Disk		mm	Dezen	Plášť Duše	PR	mm	kg	kg
3023.03	210	64	7005.08	JL	20	C 05	6006.00	4	75	1,10	150
3021.31	260	80	7005.08	JL	20	C 05	6001.16	4	75	1,30	150



Kolečka bantamová s duší 2.50-4, 3.00-4 180/200kg serie 3000

typ	mm	mm	Disk		mm	Dezen	Plášť Duše	PR	mm	kg	kg
3023.06	210	65	7051.03	JL	20	C 05	6006.00	4	75	1,25	180
3015.03	210	65	7051.02	GL	20	C 05	6006.00	4	55	1,39	180
3015.04	210	65	7051.05	GL	20	C 05	6006.00	4	75	1,50	180
3021.32	260	83	7051.02	GL	20	C 05	6001.16	4	55	1,60	200



Kolečka bantamová s duší 2.50-4, 3.00-4 150kg serie 3000

typ	mm	mm	Disk		mm	Dezen	Plášť Duše	PR	mm	kg	kg
3023.04	224	70	7005.08	JL	20	C 38	6006.01	4	75	1,25	150
3021.34	260	80	7005.08	JL	20	C 38	6001.15	2	75	1,30	150



Kolečka bantamová s duší 2.50-4, 3.00-4 200kg serie 3000

typ	mm	mm	Disk		mm	Dezen	Plášť Duše	PR	mm	kg	kg
3061.07	224	70	7051.05	GL	20	C 38	6006.01	4	75	1,60	200
3021.35	260	83	7051.05	GL	20	C 38	6001.15	2	75	1,75	200



Kolečka bantamová s duší 3.00-4, 4.00-4 150kg serie 3000

typ	mm	mm	Disk		mm	Dezen	Plášť Duše	PR	mm	kg	kg
3021.03	260	77	7005.08	JL	20	C 03	6001.00	2	75	1,25	150
3022.05	300	90	7005.08	JL	20	C 03	6002.00	4	75	1,65	150

Standardní kolo na ruční vozík - rudl.



Kolečka bantamová s duší 3.00-4 200kg serie 3000

typ	mm	mm	Disk		mm	Dezen	Plášť Duše	PR	mm	kg	kg
3021.20	260	82	7051.02	GL	20	C 03	6001.01	4	55	1,75	200
3021.21	260	82	7051.03	JL	20	C 03	6001.01	4	75	1,60	200
3021.22	260	82	7051.05	GL	20	C 03	6001.01	4	75	1,60	200



> 210 - 300 mm



Kolečka bantamová s duší 3.00-4, 4.00-4 180/225kg serie 3000

typ	mm	mm	Disk		mm	Dezen	Plášť Duše	PR	mm	kg	kg
3014.01	260	77	7004.02	GL	20	C 03	6001.00	2	55	1,70	180
3011.02	300	97	7004.02	GL	25	C 03	6002.00	4	55	2,20	225



Kolečka bantamová s duší 3.00-4 150kg serie 3000

typ	mm	mm	Disk		mm	Dezen	Plášť Duše	PR	mm	kg	kg
3021.26	260	77	7005.16	JL/KL	20/15	C 03	6001.00	2	51	1,25	150

Výhradně pro vozíky s osou o průměru 15 mm.



Kolečka bantamová s duší 3.00-4, 4.00-4 150/200/250kg serie 3000

typ	mm	mm	Disk		mm	Dezen	Plášť Duše	PR	mm	kg	kg
3014.11	260	75	7051.02	GL	20	C 17	6001.05	4	55	2,10	200
3014.12	260	75	7051.03	JL	20	C 17	6001.05	4	75	1,90	200
3014.13	260	75	7051.05	GL	20	C 17	6001.05	4	75	2,60	200
3018.18	300	95	7051.02	GL	20	C 17	6002.05	4	55	2,20	250
3018.22	300	95	7051.05	GL	20	C 17	6002.05	4	75	2,30	250
3022.14	300	95	7051.03	JL	20	C 17	6002.05	4	75	2,20	200



Kolečka bantamová s duší 3.00-4, 4.00-4 150/200kg serie 3000

typ	mm	mm	Disk		mm	Dezen	Plášť Duše	PR	mm	kg	kg
3014.10	260	75	7004.02	GL	20	C 17	6001.05	4	55	2,10	150
3027.03	300	95	7004.01	GL	25	C 17	6002.05	4	55	2,50	200



Kolečka bantamová s duší 3.00-4 150kg serie 3000

typ	mm	mm	Disk		mm	Dezen	Plášť Duše	PR	mm	kg	kg
3021.37	260	77	7005.08	JL	20	C 02	6001.17	4	75	1,25	150



Kolečka bantamová s duší 3.00-4 180kg serie 3000

typ	mm	mm	Disk		mm	Dezen	Plášť Duše	PR	mm	kg	kg
3014.14	260	75	7004.02	GL	20	C 02	6001.17	4	55	2,30	180

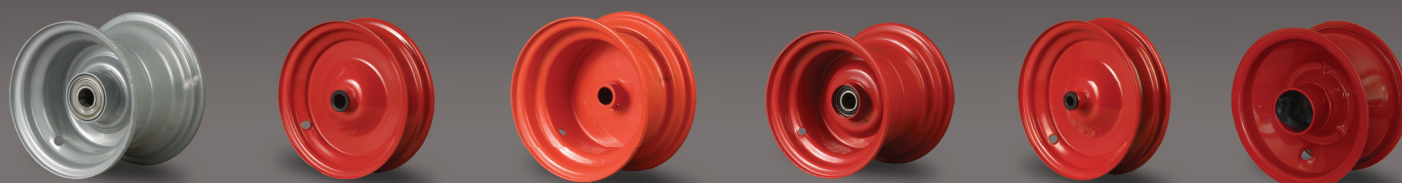

> 210 - 300 mm



Kolečka bantamová s duší 4.10/3.50-4 200kg serie 3000

typ	mm	mm	Disk		mm	Dezen	Plášť Duše	PR	mm	kg	kg
3026.02	270	85	7004.02	GL	20	C 10	6027.00	2	55	2,30	200



Kolečka bantamová s duší 4.10/3.50-4, 4.00-4 150kg serie 3000

typ	mm	mm	Disk		mm	Dezen	Plášť Duše	PR	mm	kg	kg
3026.05	270	88	7005.08	JL	20	C 10	6027.00	2	75	1,65	150
3022.04	300	100	7005.08	JL	20	C 10	6002.02	4	75	1,70	150



Kolečka bantamová s duší 4.10/3.50-4, 4.00-4 200/225/250kg serie 3000

typ	mm	mm	Disk		mm	Dezen	Plášť Duše	PR	mm	kg	kg
3026.17	270	90	7051.02	GL	20	C 10	6027.05	4	55	2,20	225
3026.18	270	90	7051.03	JL	20	C 10	6027.05	4	75	2,10	200
3026.19	270	90	7051.05	GL	20	C 10	6027.05	4	75	2,18	225
3018.08	300	100	7051.02	GL	20	C 10	6002.02	4	55	2,20	250
3018.09	300	100	7051.03	JL	20	C 10	6002.02	4	75	1,80	200
3018.14	300	100	7051.05	GL	20	C 10	6002.02	4	75	2,32	250



Kolečka bantamová s duší 4.00-4 225kg serie 3000

typ	mm	mm	Disk		mm	Dezen	Plášť Duše	PR	mm	kg	kg
3018.03	300	97	7004.02	GL	20	C 10	6002.02	4	55	2,30	225



Kolečka bantamová s duší 4.00-4 200/250kg serie 3000

typ	mm	mm	Disk		mm	Dezen	Plášť Duše	PR	mm	kg	kg
3018.10	300	100	7051.02	GL	20	C 03	6002.00	4	55	1,76	250
3018.11	300	100	7051.03	JL	20	C 03	6002.00	4	75	1,63	200
3018.15	300	100	7051.05	GL	20	C 03	6002.00	4	75	1,85	250

> 320 - 350 mm



Kolečka bantamová s duší 3.50-6, 4.00-6 180/200kg serie 3000

typ	mm	mm	Disk		mm	Dezen	Plášť Duše	PR	mm	kg	kg
3068.03	320	95	7027.03	JL	20	C 01	6020.00	2	75	2,3	180
3068.04	320	95	7007.04	GL	20	C 01	6020.00	2	52	2,5	180
3004.11	350	100	7027.03	JL	20	C 01	6025.02	4	75	2,4	200
3004.22	350	100	7007.04	GL	20	C 01	6025.02	4	52	2,6	200



Kolečka bantamová s duší 4.00-6 200kg serie 3000

typ	mm	mm	Disk		mm	Dezen	Plášť Duše	PR	mm	kg	kg
3004.12	350	95	7027.03	JL	20	C 10	6025.05	6	75	2,65	200
3004.13	350	95	7007.04	GL	20	C 10	6025.05	6	52	2,90	200



Kolečka bantamová s duší 3.50-6 180kg serie 3000

typ	mm	mm	Disk		mm	Dezen	Plášť Duše	PR	mm	kg	kg
3068.05	320	90	7027.03	JL	20	C 03	6020.03	4	75	2,50	180
3068.06	320	90	7007.04	GL	20	C 03	6020.03	4	52	2,80	180



Kolečka bantamová s duší 4.00-6 180kg serie 3000

typ	mm	mm	Disk		mm	Dezen	Plášť Duše	PR	mm	kg	kg
3004.09	350	105	7027.03	JL	20	C 07	6025.03	4	75	2,75	180
3032.02	350	105	7007.04	GL	20	C 07	6025.03	4	52	3,05	180



Kolečka bantamová s duší 3.50-6 200kg serie 3000

typ	mm	mm	Disk		mm	Dezen	Plášť Duše	PR	mm	kg	kg
3068.01	320	90	7027.03	JL	20	C 17	6020.01	4	75	3,33	200
3068.10	320	90	7007.04	GL	20	C 17	6020.01	4	52	3,55	200



Kolečka bantamová s duší 3.50-6 s otvorem pro kolík 200kg serie 3000

typ	mm	mm	Disk		mm	Dezen	Plášť Duše	PR	mm	kg	kg
3068.11	320	90	7034.00	KL	20	C 03	6020.03	4	60	2,65	200

Průměry pneu

průměr pneu (mm)	rozměr pláště	průměr pneu (mm)	rozměr pláště
200	200 x 50	280-300	4.00-4
210 Dezen C05	2.50-4	320	3.50-6
224 Dezen C38	2.50-4	350	4.00-6
260	3.00-4	370	3.50-8
270	4.10/3.50-4	400	4.80/4.00-8 4.00-8



Kolečka bantamová s duší 4.00-6 s otvorem pro kolík 200 kg serie 3000

typ	mm	mm	Disk		mm	Dezen	Plášť Duše	PR	mm	kg	kg
3004.26	350	95	7034.00	OK	20	C 10	6025.05	6	60	2,68	200



Kolečka bantamová s duší 3.50-6, 4.00-6 180/ 200kg serie 3000

typ	mm	mm	Disk		mm	Dezen	Plášť Duše	PR	mm	kg	kg
3068.07	320	95	7007.26	JL	20	C 01	6020.00	2	75	2,50	180
3068.08	320	95	7007.23	GL	20	C 01	6020.00	2	72	2,80	180
3004.19	350	100	7007.26	JL	20	C 01	6025.02	4	75	2,60	200
3004.23	350	100	7007.23	GL	20	C 01	6025.02	4	72	2,90	200



Kolečka bantamová s duší 4.00-6 200kg serie 3000

typ	mm	mm	Disk		mm	Dezen	Plášť Duše	PR	mm	kg	kg
3004.16	350	100	7007.21	JL	20	C 10	6025.05	6	75	2,87	200
3004.18	350	100	7007.23	GL	20	C 10	6025.05	6	72	3,50	200



Kolečka bantamová s duší 3.50-6 200kg serie 3000

typ	mm	mm	Disk		mm	Dezen	Plášť Duše	PR	mm	kg	kg
3068.02	320	95	7007.26	JL	20	C 03	6020.03	4	75	3,00	200
3068.09	320	95	7007.23	GL	20	C 03	6020.03	4	72	3,30	200



> 400 mm



Kolečka bantamová s duší 4.00-8 TR13 200kg serie 3000

typ	mm	mm	Disk		mm	Dezen	Plášť Duše	PR	mm	kg	kg
3161.01	400	100	7061.01	KL	12	C 01	6004.00	2	105	2,50	200
3163.01	400	100	7063.01	JL	20	C 01	6004.00	2	75	2,70	200
3161.03	400	100	7061.02	KL	12	C 01	6004.00	2	100	2,50	200



Kolečka bantamová s duší 4.00-8 TR13 200kg serie 3000

typ	mm	mm	Disk		mm	Dezen	Plášť Duše	PR	mm	kg	kg
3164.01	400	100	7064.01	GL	20	C 01	6005.00	4	55	2,80	200
3165.01	400	100	7065.01	GL	20	C 01	6005.00	4	80	2,90	200
3165.41	400	100	7065.22	GL	20	C 01	6005.00	4	74	3,00	200



Kolečka bantamová s duší 4.00-8 TR13 200kg serie 3000

typ	mm	mm	Disk		mm	Dezen	Plášť Duše	PR	mm	kg	kg
3164.05	400	105	7064.01	GL	17	C 03	6005.04	4	55	3,60	200
3163.04	400	105	7063.01	JL	20	C 03	6005.04	4	75	3,40	200
3164.02	400	105	7064.01	GL	20	C 03	6005.04	4	55	3,55	200
3165.02	400	105	7065.01	GL	20	C 03	6005.04	4	80	3,80	200
3165.42	400	105	7065.22	GL	20	C 03	6005.04	4	74	3,70	200



Kolečka bantamová s duší 4.00-8 300kg serie 3000

typ	mm	mm	Disk		mm	Dezen	Plášť Duše	PR	mm	kg	kg
3005.21	400	100	7011.30	GL	25	C 10	6034.02	6	80	4,00	300



Kolečka bantamová s duší 4.00-8 TR13 300kg serie 3000

typ	mm	mm	Disk		mm	Dezen	Plášť Duše	PR	mm	kg	kg
3005.57	400	100	7011.30	GL	25	C 03	6005.04	6	80	4,35	300
3005.66	400	100	7011.58	GL	20	C 03	6005.04	6	80	4,25	300

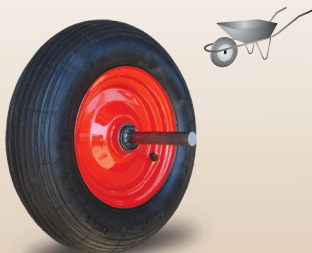

Kolečka bantamová s duší 4.00-8 TR13 200kg serie 3000

typ	mm	mm	Disk		mm	Dezen	Plášť Duše	PR	mm	kg	kg
3164.06	400	100	7064.01	GL	20	C 01	6005.00	4	55	3,50	200

Většně osky průměr 20h11 L=300mm

Průměry pneu

průměr pneu (mm)	rozměr pláště	průměr pneu (mm)	rozměr pláště
200	200 x 50	280-300	4.00-4
210 Dezen C05	2.50-4	320	3.50-6
224 Dezen C38	2.50-4	350	4.00-6
260	3.00-4	370	3.50-8
270	4.10/3.50-4	400	4.80/4.00-8
			4.00-8



Kolečka bantamová s duší 2.50-4 150kg serie 3000

typ	mm	mm	Disk		mm	Dezen	Plášť Duše	PR	mm	kg	kg
3008.03	210Š	65	7005.08	JL	20	C 05	6006.02	4	75	1,07	150



Kolečka bantamová s duší 2.50-4 150kg serie 3000

typ	mm	mm	Disk		mm	Dezen	Plášť Duše	PR	mm	kg	kg
3008.04	210Š	65	7005.08	JL	20	C 43	6706.03 + 6505.00	2	75	1,10	150



Kolečka bantamová s duší 2.50-4 150kg serie 3000

typ	mm	mm	Disk		mm	Dezen	Plášť Duše	PR	mm	kg	kg
3008.05	210Š	65	7005.08	JL	20	C 01	6706.04 + 6505.00	2	75	1,25	150



Kolečka bantamová s duší 3.00-4, 4.00-4 150kg serie 3000

typ	mm	mm	Disk		mm	Dezen	Plášť Duše	PR	mm	kg	kg
3021.06	260Š	80	7005.08	JL	20	C 03	6001.09	4	75	1,10	150
3022.10	300Š	95	7005.08	JL	20	C 03	6002.10	4	75	1,35	150

průměr pneu (mm)	rozměr pláště	průměr pneu (mm)	rozměr pláště
200	200 x 50	280-300	4.00-4
210 Dezen C05	2.50-4	320	3.50-6
224 Dezen C38	2.50-4	350	4.00-6
260	3.00-4	370	3.50-8
270	4.10/3.50-4	400	4.80/4.00-8
			4.00-8

> kolečka šípová



Kolečka bantamová s duší 3.004-4 šíp 250/200kg serie 3000

typ	mm	mm	Disk		mm	Dezen	Plášť Duše	PR	mm	kg	kg
3018.20	300	90	7051.06	OK	25	C 12	6045.00	4	80	2,55	250
3021.24	260	90	7051.06	OK	25	C 12	6016.00	4	80	2,10	200

Otvor pro kolík průměr 8 mm



Kolečka bantamová s duší 3.50-6 200/250kg serie 3000

typ	mm	mm	Disk		mm	Dezen	Plášť Duše	PR	mm	kg	kg
3048.01	390	90	7031.00	OK	25	C 12	6029.00	4	60	4,84	250
3068.12	350	80	7034.00	OK	19	C 12	6046.00	4	60	4,0	200

Otvor pro kolík 8mm



Kolečka bantamová s duší 4.00-8 300kg serie 3000

typ	mm	mm	Disk		mm	Dezen	Plášť Duše	PR	mm	kg	kg
3049.01	420	100	7031.00	OK	25	C 12	6017.01	4	80	4,95	300

Otvor pro kolík 8mm



Kolečka bantamová s duší 4.00-8 300kg serie 3000

typ	mm	mm	Disk		mm	Dezen	Plášť Duše	PR	mm	kg	kg
3049.05	420	100	7064.01	GL	20	C 12	6017.01	4	55	3,80	300



Kolečka bantamová s duší 16 x 6.50-8 280kg serie 3000

typ	mm	mm	Disk		mm	Dezen	Plášť Duše	PR	mm	kg	kg
3070.01	420	150	7036.00	OK	25	C 15	6057.01	6	60	6,39	280

Legenda:

- JL - jehlové ložisko
- KL - kluzné ložisko
- GL - kuličkové ložisko
- OK - otvor pro kolík

> kola na přírubách



Kolečka bantamová s duší 4.80/4.00-8 300kg serie 3000

typ	mm	mm	Disk	Otvor počet ks/ rozměr	Průměr střed. otvoru (mm)	Rozteč otvorů (mm)	Dezen	Plášť Duše	PR	kg	kg
3005.51	400	100	7038.01	4/14	58	98	C 25	6034.04	6	4,30	300

Pro šrouby M 12



Kolečka bantamová s duší 16x6.50-8 400kg serie 3000

typ	mm	mm	Disk	Otvor počet ks/ rozměr	Průměr střed. otvoru (mm)	Rozteč otvorů (mm)	Dezen	Plášť Duše	PR	kg	kg
3030.04	410	160	7039.01	4/14	58	98	C 10	6009.01	6	5,85	400

Pro šrouby M 12



Kolečka bantamová s duší 145-10R 400kg serie 3000

typ	mm	mm	Disk	Otvor počet ks/ rozměr	Průměr střed. otvoru (mm)	Rozteč otvorů (mm)	Dezen	Plášť Duše	PR	kg	kg
3058.04	490	130	7016.03	4/14	58	98	C 27	145-10R	6	7,40	400

Pro šrouby M 12



Kolečka bantamová s duší 6.00/9 1600kg serie 3000

typ	mm	mm	Disk	Otvor počet ks/ rozměr	Průměr střed. otvoru (mm)	Rozteč otvorů (mm)	Dezen	Plášť Duše	PR	kg	kg
3071.02	540	140	7052.01	5/18	93	140	C 32	6079.00	10	16,50	1600

Pro šrouby M 16



Kolečka bantamová s duší 6.00/9 1600kg serie 3000

typ	mm	mm	Otvor počet ks/ rozměr	Průměr střed. otvoru (mm)	Rozteč otvorů (mm)	Dezen	PR	kg	kg
3074.01	545	240	4/14	58	98	C 29	4	9,80	200

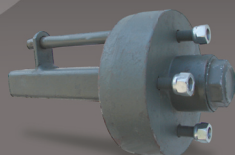
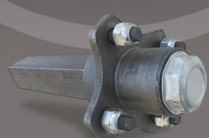

> kola 13x5.00-6 a 13x6.50-6



Kolečka bantamová s duší 13x5.00-6 220kg serie 3000

typ	mm	mm	Disk		mm	Dezen	Plášť Duše	PR	mm	kg	kg
3072.05	320	105	7014.05	JL	20	C 10	6013.01	4	80	3,20	220



Kolečka bantamová s duší 13x5.00-6 220kg serie 3000

typ	mm	mm	Disk		mm	Dezen	Plášť Duše	PR	mm	kg	kg
3072.06	320	105	7014.01	GL	25	C 10	6013.01	4	51,5	3,50	220



Kolečka bantamová s duší 13x5.00-6 220kg serie 3000

typ	mm	mm	Disk		mm	Dezen	Plášť Duše	PR	mm	kg	kg
3072.01	320	120	7014.05	JL	20	C 09	6013.06	4	80	3,27	220
3072.07	320	120	7014.01	GL	25	C 09	6013.06	4	51,5	3,55	220



Kolečka bantamová s duší 13x5.00-6 220kg serie 3000

typ	mm	mm	Disk		mm	Dezen	Plášť Duše	PR	mm	kg	kg
3072.02	320	120	7014.09	drážka	20	C 10	6013.01	4	30	3,23	220



Kolečka bantamová s duší 13x6.50-6 220kg serie 3000

typ	mm	mm	Disk		mm	Dezen	Plášť Duše	PR	mm	kg	kg
3072.04	320	140	7014.70	GL	25	C 10	6011.00	4	80	3,90	220

Legenda:

JL - jehlové ložisko

GL - kuličkové ložisko

> kolečka

> kolečka bantamová s duší - kovový disk > 180 - 260 kg > serie 3000

> kola 15x6.00-6



Kolečka bantamová s duší 15x6.00-6 180kg serie 3000

typ	mm	mm	Disk		mm	Dezen	Plášť Duše	PR	mm	kg	kg
3069.04	370	145	7014.05	JL	20	C 10	6008.03	4	80	3,90	180



Kolečka bantamová s duší 15x6.00-6 250kg serie 3000

typ	mm	mm	Disk		mm	Dezen	Plášť Duše	PR	mm	kg	kg
3069.01	350	145	7014.70	GL	25	C 09	6008.09	10	80	4,90	250
3069.05	350	145	7014.01	GL	25	C 09	6008.09	10	51	4,90	250



Kolečka bantamová s duší 15x6.00-6 260kg serie 3000

typ	mm	mm	Disk		mm	Dezen	Plášť Duše	PR	mm	kg	kg
3025.01	370	140	7014.01	GL	25	C 10	6008.03	4	51	4,10	260
3069.03	370	140	7014.70	GL	25	C10	6008.03	4	80	4,30	260



> kola 16x6.50-8



Kolečka bantamová s duší 16x6.50-8 450kg serie 3000

typ	mm	mm		mm	Dezen	PR	mm	kg	kg
3030.01	410	170	GL	25	C 09	6	70	7,45	450



Kolečka bantamová s duší 16x6.50-8 400kg serie 3000

typ	mm	mm	Disk		mm	Dezen	Plášť Duše	PR	mm	kg	kg
3030.16	410	170	7015.02	GL	25	C 09	6009.02	6	70	6,60	400



Kolečka bantamová s duší 16x6.50-8 450kg serie 3000

typ	mm	mm	Disk		mm	Dezen	Plášť Duše	PR	mm	kg	kg
3030.13	410	170	7015.09	GL	20	C 09	6009.04	10	98/89	6,90	450
3030.12	410	170	7015.04	GL	20/25	C 09	6009.04	10	96/89	6,00	450
3030.14	410	170	7015.04	GL	20	C 09	6009.04	10	96/89	6,50	450



Kolečka bantamová s duší 16x6.50-8 300/400kg serie 3000

typ	mm	mm	Disk		mm	Dezen	Plášť Duše	PR	mm	kg	kg
3030.15	410	165	7015.02	GL	25	C 10	6009.00	4	70	6,50	300
3030.18	410	165	7015.02	GL	25	C 10	6009.01	6	70	6,50	400



Kolečka bantamová s duší 16x6.50-8 300kg serie 3000

typ	mm	mm	Disk		mm	Dezen	Plášť Duše	PR	mm	kg	kg
3030.17	410	150	7036.00	OK	25	C 10	6009.00	4	60	6,60	300

Legenda:

- JL - jehlové ložisko
- GL - kuličkové ložisko
- KL - kluzné uložení
- OK - otvor pro kolík



Kolečka bantamová s duší 18.5x8.5-8 400kg serie 3000

typ	mm	mm	Disk		mm	Dezen	Plášť Duše	PR	mm	kg	kg
3063.02	475	190	7015.04	GL	20/25	C 28	P6768.00 + D6526.00	6	96/88	10	400



Kolečka bantamová s duší 18 x 8.50-8 400kg serie 3000

typ	mm	mm	Disk		mm	Dezen	Plášť Duše	PR	mm	kg	kg
3029.07	460	200	7015.02	GL	25	C 44	6010.00	4	70	9,40	400



Kolečka bantamová s duší 18x9.50-8 400kg serie 3000

typ	mm	mm			mm	Dezen	PR	mm	kg	kg
3028.01	465	200	GL		25	C 10	4	92	9,60	400



Kolečka bantamová s duší 18x8.50-8 400kg serie 3000

typ	mm	mm	Disk		mm	Dezen	Plášť Duše	PR	mm	kg	kg
3029.05	460	190	7036.00	OK	25	C 44	6010.06	4	60	8,8	400



> kolečka ostatní



Kolečka bantamová s duší 4.50-10 500kg serie 3000

typ	mm	mm	GL	mm	Dezen	PR	mm	kg	kg
3031.01	490	130	GL	25	C 27	6	53/73	8,50	500



Kolečka bantamová s duší 6.00-9 1600kg serie 3000

typ	mm	mm	GL	mm	Dezen	PR	mm	kg	kg
3071.01	540	160	GL	35	C 60	12	80	12,60	1600



Kolečko pevné bantamové s duší 200 x 50 130kg serie 16000

typ	mm	Typ kola	mm		mm	mm	mm	mm	mm	kg	kg
16200.10	200	4030.02	50	JL	250	140 x 110	105 x 80	12	1,85	130	
16200.12	200Š	4030.03	50	JL	250	140 x 110	105 x 80	12	1,85	130	



Kolečko otočné bantamové s duší 200 x 50 130kg serie 16000

typ	mm	Typ kola	mm		mm	mm	mm	mm	mm	kg	kg
16200.11	200	4030.02	50	JL	250	65	140 x 110	105 x 80	12	2,36	130
16200.13	200Š	4030.03	50	JL	250	65	140 x 110	105 x 80	12	2,36	130



Kolečko pevné bantamové s duší 2.50/2.80-4 130kg serie 16000

typ	mm	Typ kola	mm		mm	mm	mm	mm	mm	kg	kg
16210.10	200	3023.03	70	JL	260	140 x 110	105 x 80	12	2,38	130	
16210.13	210Š	3008.03	70	JL	260	140 x 110	105 x 80	12	2,38	130	



Kolečko otočné bantamové s duší 2.50/2.80-4 130kg serie 16000

typ	mm	Typ kola	mm		mm	mm	mm	mm	mm	kg	kg
16210.11	210	3023.03	70	JL	260	65	140 x 110	105 x 80	12	3,00	130
16210.14	210Š	3008.03	70	JL	260	65	140 x 110	105 x 80	12	3,00	130



Kolečko pevné bantamové s duší 3.00-4 130kg serie 16000

typ	mm	Typ kola	mm		mm	mm	mm	mm	mm	kg	kg
16260.08	260	3021.03	85	JL	300	150 x 120	105 x 80	13	3,20	130	
16260.23	260Š	3021.06	85	JL	300	150 x 120	105 x 80	11	3,20	130	



Kolečko otočné bantamové s duší 3.00-4 130kg serie 16000

typ	mm	Typ kola	mm		mm	mm	mm	mm	mm	kg	kg
16260.07	260	3021.03	85	JL	300	70	140 x 110	105 x 80	13	4	130
16260.24	260Š	3021.06	85	JL	300	70	140 x 110	105 x 80	11	4	130

Š = šedý plášť

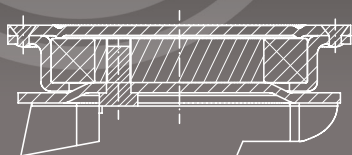

> otočná



Kolečko pevné bantamové s duší 3.00-4 150kg serie 16000

typ	mm	Typ kola	mm		mm	mm	mm	mm	mm	kg	kg
16260.20	260	3021.37	85	JL	300	150 x 120	105 x 80	11	3,20	150	



Kolečko otočné bantamové s duší 3.00-4 150kg serie 16000

typ	mm	Typ kola	mm		mm	mm	mm	mm	mm	kg	kg
16260.19	260	3021.37	85	JL	300	70	140 x 110	105 x 80	11	4	150



Kolečko pevné bantamové s duší 3.00-4 150kg serie 16000

typ	mm	Typ kola	mm		mm	mm	mm	mm	mm	kg	kg
16260.22	260	3014.12	80	JL	300	150 x 120	105 x 80	11	3,90	150	



Kolečko otočné bantamové s duší 3.00-4 150kg serie 16000

typ	mm	Typ kola	mm		mm	mm	mm	mm	mm	kg	kg
16260.21	260	3014.12	80	JL	300	70	140 x 110	105 x 80	11	4,05	150



Kolečko pevné bantamové s duší 3.00-4 130kg serie 16000

typ	mm	Typ kola	mm		mm	mm	mm	mm	mm	kg	kg
16260.10	260	3021.21	85	JL	300	170 x 170	140 x 140	11	3,50	130	



Kolečko otočné bantamové s duší 3.00-4 130kg serie 16000

typ	mm	Typ kola	mm		mm	mm	mm	mm	mm	kg	kg
16260.11	260	3021.21	85	JL	300	70	170 x 170	140 x 140	11	3,70	130

Průměry pneu

průměr pneu (mm)	rozměr pláště	průměr pneu (mm)	rozměr pláště
200	200 x 50	280-300	4,00-4
210 Dežén C05	2,50-4	320	3,50-6
224 Dežén C38	2,50-4	350	4,00-6
260	3,00-4	370	3,50-8
270	4,10/3,50-4	400	4,80/4,00-8 4,00-8



Kolečko otočné bantamové s brzdou s duší 3.00-4 130kg serie 16000

typ	mm	Typ kola	mm		mm	mm	mm	mm	mm	kg	kg
16260.12	260	3021.21	85	JL	300	70	170 x 170	140 x 140	11	3,80	130



Kolečko pevné bantamové s duší 200/300kg serie 16000

typ	mm	Typ kola	mm		mm	mm	mm	mm	mm	kg	kg
16260.14	260	3014.13	80	GL	340		180 x 150	140 x 120	11	6,40	200
16300.12	300	3018.22	100	GL	380		180 x 150	140 x 120	11	7,00	200
16350.03	350	3004.21	100	GL	405		180 x 150	140 x 120	11	7,75	200



Kolečko otočné bantamové s duší 200/300kg serie 16000

typ	mm	Typ kola	mm		mm	mm	mm	mm	mm	kg	kg
16260.15	260	3014.13	80	GL	340	90	180 x 150	140 x 120	11	9,05	200
16300.13	300	3018.22	100	GL	380	90	180 x 150	140 x 120	11	10,05	200
16350.04	350	3004.21	100	GL	405	90	180 x 150	140 x 120	11	10,75	200



Kolečko pevné bantamové s duší 200kg serie 16000

typ	mm	Typ kola	mm		mm	mm	mm	mm	mm	kg	kg
16270.12	270	3026.19	90	GL	345		180 x 150	140 x 120	11	6,00	200
16300.10	300	3018.14	100	GL	380		180 x 150	140 x 120	11	7,00	200
16350.01	350	3004.13	100	GL	405		180 x 150	140 x 120	11	7,75	200



Kolečko otočné bantamové s duší 200/300kg serie 16000

typ	mm	Typ kola	mm		mm	mm	mm	mm	mm	kg	kg
16270.13	270	3026.19	90	GL	345	90	180 x 150	140 x 120	11	8,70	200
16300.11	300	3018.14	100	GL	380	90	180 x 150	140 x 120	11	10,05	200
16350.02	350	3004.13	100	GL	405	90	180 x 150	140 x 120	11	10,75	200

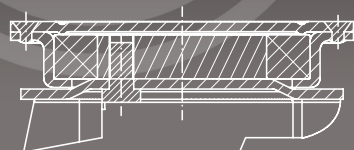

> samostatná, plastový disk



Kolečka bantamová s duší 70kg serie 4000

typ	mm	mm	Disk		mm	Dezen	Plášť Duše	PR	mm	kg	kg
4031.01	180 Š	42	7216.00	JL	20	C 01	6714.00 + 6513.00	2	59	0,42	70
4030.03	200 Š	50	7216.00	JL	20	C 01	6007.02	2	59	0,48	70

Šedé nešpinivé provedení do interiéru.



Kolečka bantamová s duší 200x50 100kg serie 4000

typ	mm	mm	Disk		mm	Dezen	Plášť Duše	PR	mm	kg	kg
4030.02	200	50	7216.00	JL	20	C 01	6007.01	2	59	0,52	100



Kolečka bantamová s duší 2.50/2.80-4 135kg serie 4000

typ	mm	mm	Disk		mm	Dezen	Plášť Duše	PR	mm	kg	kg
4005.01	210	65	7206.03	KL	20	C 05	6006.00	4	73	0,87	135
4006.01	210	65	7906.01	JL	20	C 05	6006.00	4	75	0,91	135



Kolečka bantamová s duší 2.50/2.80-4 135kg serie 4000

typ	mm	mm	Disk		mm	Dezen	Plášť Duše	PR	mm	kg	kg
4027.01	210	62	7203.00	GL	12	C 05	6006.00	4	65	1,12	135
4027.02	210	62	7203.01	GL	15	C 05	6006.00	4	65	1,12	135

Kuličková ložiska v kole.



Kolečka bantamová s duší 2.50-4 135 kg serie 4000

typ	mm	mm	Disk		mm	Dezen	Plášť Duše	PR	mm	kg	kg
4005.02	210 Š	65	7206.03	KL	20	C 05	6006.02	4	75	0,70	135
4006.02	210 Š	65	7906.01	JL	20	C 05	6006.02	4	75	0,75	135

Šedé nešpinivé provedení do interiéru.



Kolečka bantamová s duší 2.50/2.80-4 135kg serie 4000

typ	mm	mm	Disk		mm	Dezen	Plášť Duše	PR	mm	kg	kg
4032.03	224	70	7206.03	KL	20	C 38	6006.01	4	73	0,82	135
4032.04	224	70	7906.01	JL	20	C 38	6006.01	4	75	0,90	135

Průměry pneu

průměr pneu (mm)	rozměr pláště	průměr pneu (mm)	rozměr pláště
200	200 x 50	280-300	4.00-4
210 Dezen C05	2.50-4	320	3.50-6
224 Dezen C38	2.50-4	350	4.00-6
260	3.00-4	370	3.50-8
270	4.10/3.50-4	400	4.80/4.00-8 4.00-8





Kolečka bantamová s duší 2.50/2.80-4 150kg serie 4000

typ	mm	mm	Disk		mm	Dezen	Plášť Duše	PR	mm	kg	kg
4032.01	224	70	7203.00	GL	12	C 38	6006.01	4	65	1,20	150
4032.02	224	70	7203.01	GL	15	C 38	6006.01	4	65	1,20	150

Kuličková ložiska v kole.



Kolečka bantamová s duší 3.00-4/4.00-4 135/150kg serie 4000

typ	mm	mm	Disk		mm	Dezen	Plášť Duše	PR	mm	kg	kg
4001.01	260	81	7206.03	KL	20	C 03	6001.00	2	73	0,93	135
4002.01	260	81	7906.01	JL	20	C 03	6001.00	2	75	1,00	150
4003.01	300	100	7206.03	KL	20	C 03	6002.00	4	73	1,50	150
4004.07	300	100	7906.01	JL	20	C 03	6002.00	4	75	1,40	150

Univerzální kolo na rudl, vozík.



Kolečka bantamová s duší 3.00-4/4.00-4 170kg serie 4000

typ	mm	mm	Disk		mm	Dezen	Plášť Duše	PR	mm	kg	kg
4020.01	260	81	7203.00	GL	12	C 03	6001.00	2	65	1,37	170
4021.01	260	81	7203.01	GL	15	C 03	6001.00	2	65	1,37	170
4025.01	300	100	7203.00	GL	12	C 03	6002.00	4	65	1,70	170
4025.02	300	100	7203.01	GL	15	C 03	6002.00	4	65	1,70	170

Kuličková ložiska v kole.



Kolečka bantamová s duší 2.50-4, 3.00-4 135kg serie 4000

typ	mm	mm	Disk		mm	Dezen	Plášť Duše	PR	mm	kg	kg
4005.03	210 Š	60	7906.01	JL	20	C 01	6706.04 + 6505.00	2	75	0,79	135
4002.03	260 Š	81	7906.01	JL	20	C 01	6001.03	2	75	0,84	135

Šedé nešpinivé provedení do interiéru.



Kolečka bantamová s duší 3.00-4, 4.00-4 135kg serie 4000

typ	mm	mm	Disk		mm	Dezen	Plášť Duše	PR	mm	kg	kg
4002.11	260 Š	80	7206.03	KL	20	C 03	6001.09	4	75	0,95	135
4002.09	260 Š	80	7906.01	JL	20	C 03	6001.09	4	75	1,00	135
4003.02	300 Š	95	7206.03	KL	20	C 03	6002.10	4	75	1,00	135
4004.08	300 Š	95	7906.01	JL	20	C 03	6002.10	4	75	1,10	135

Šedé nešpinivé provedení do interiéru.



Kolečka bantamová s duší 4.10x3.50-4 150kg serie 4000

typ	mm	mm	Disk		mm	Dezen	Plášť Duše	PR	mm	kg	kg
4019.02	270	95	7206.03	KL	20	C 10	6027.00	2	73	1,55	150
4018.02	270	95	7906.00	JL	20	C 10	6027.00	2	73	1,51	150

> samostatná, plastový disk



Kolečka bantamová s duší 4.10/3.50-4, 4.00-4 170kg serie 4000

typ	mm	mm	Disk		mm	Dezen	Plášť Duše	PR	mm	kg	kg
4026.01	270	89	7203.00	GL	12	C 10	6027.00	2	65	1,65	170
4026.02	270	89	7203.01	GL	15	C 10	6027.00	2	65	1,65	170
4025.03	300	97	7203.00	GL	12	C 10	6002.02	4	65	1,71	170
4025.04	300	97	7203.01	GL	15	C 10	6002.02	4	65	1,71	170

Kuličková ložiska v kole.



Kolečka bantamová s duší 3.50-6 130kg serie 4000

typ	mm	mm	Disk		mm	Dezen	Plášť Duše	PR	mm	kg	kg
4013.03	350	98	7207.01	KL	12	C 01	6003.00	2	91	1,50	130
4013.01	350	98	7207.00	KL	20	C 01	6025.02	2	91	1,50	130



Kolečka bantamová s duší 3.50-8, 4.00-8 150/180kg serie 4000

typ	mm	mm	Disk		mm	Dezen	Plášť Duše	PR	mm	kg	kg
4024.01	370	88	7208.01	GL	20	C 01	6028.01	2	71	2,00	150
4016.02	400	96	7208.01	GL	20	C 01	6004.00	2	71	2,05	180



Kolečka bantamová s duší 3.50-8, 4.00-8 150kg serie 4000

typ	mm	mm	Disk		mm	Dezen	Plášť Duše	PR	mm	kg	kg
4023.03	370	88	7211.00	KL	20	C 01	6028.00	2	50	1,92	150
4028.01	370	88	7215.01	JL	20	C 01	6028.00	2	75	1,88	150
4029.01	400	96	7215.01	JL	20	C 01	6004.00	2	75	1,93	150
4017.01	400	100	7211.00	KL	20	C 01	6004.00	2	50	1,97	150



Kolečka bantamová s duší 22x11.00-8 135kg serie 4000

typ	mm	mm	Disk		mm	Dezen	Plášť	PR	mm	kg	kg
4033.01	550	220	KL		30	C 01	6769.03	2	105	6	135

Průměry pneu

průměr pneu (mm)	rozměr pláště	průměr pneu (mm)	rozměr pláště
200	200 x 50	280-300	4,00-4
210 Dezen C05	2,50-4	320	3,50-6
224 Dezen C38	2,50-4	350	4,00-6
260	3,00-4	370	3,50-8
270	4,10/3,50-4	400	4,80/4,00-8 4,00-8



Kolečka bantamová s duší 2.50/2.80-4 180kg serie 3500

typ	mm	mm	Disk		mm	Dezen	Plášť Duše	PR	mm	kg	kg
3501.01	210	70	7101.02	GL	17	C 05	6006.00	4	78	1,50	180



Kolečka bantamová s duší 3.00-4 200kg serie 3500

typ	mm	mm	Disk		mm	Dezen	Plášť Duše	PR	mm	kg	kg
3502.01	260	82	7101.02	GL	17	C 03	6001.01	4	78	1,55	200



Kolečka bantamová s duší 4.00-4 250kg serie 3500

typ	mm	mm	Disk		mm	Dezen	Plášť Duše	PR	mm	kg	kg
3504.01	300	100	7101.02	GL	17	C 03	6002.00	4	78	1,90	250



Kolečka bantamová s duší 4.00-8 250kg serie 3500

typ	mm	mm	Disk		mm	Dezen	Plášť Duše	PR	mm	kg	kg
3505.02	400	100	7105.03	GL	20	C 28	6005.05	6	76	4,56	250





Kolečka bantamová s duší 4.00-8 vč.brzdy 250kg serie 3500

typ	mm	mm	Disk		mm	Dezen	Plášť Duše	PR	mm	kg	kg
3505.03	400	100	7105.03	GL	20	C 01	6005.01	4	76	4,25	250

> plastová loukot'





Kolečka bantamová s plastovou loukotí serie 3700

	 typ	Samostatný plášť	Samostatná duše	Dezen	 kg	 kg
1	3730.01	6112.01	6212.01	CV 16	0,68	50
2	3730.02	6112.02	6212.01	CV 26	0,68	50
3	3730.03	6112.03	6212.01	CV 36	0,68	50
4	3730.04	6112.04	6212.01	CV 41	0,71	50
5	3730.05	6112.05	6212.01	CV 57	0,70	50
6	3730.06	6112.06	6212.01	CV 10	0,72	50
7	3730.07	6112.07	6212.01	CV 63	0,75	50
8	3730.08	6112.08	6212.01	CV 20	0,75	50



Kolečka bantamová vypletená serie 3600

	 typ	Samostatný plášť	Samostatná duše	Dezen	 kg	 kg
1	3620.01	6120.01	6516.00	CV 45	1,74	70
2	3620.02	6120.02	6516.00	CV 39	1,62	70
3	3620.03	6120.03	6516.00	CV 67	1,78	70
4	3620.04	6120.04	6516.00	CV 81	1,64	70
5	3620.05	6120.05	6516.00	CV 89	1,76	70
6	3620.06	6120.06	6516.00	CV 75	1,80	70
7	3620.07	6120.07	6516.00	CV 78	1,70	70
8	3620.08	6120.08	6516.00	CV 92	1,86	70



**kolečka pojezdová,
pryžžová, otočná**



Kolečka serie 1000

typ	mm	mm		mm	mm	kg	kg
1012.01	100	30	KP	12	30	0,32	60
1013.01	125	31	KP	12	30	0,50	60
1013.02	125	31	KP	20	26	0,52	60
1011.01	140	32	KP	15	40	0,60	70



Kolečka serie 1000

typ	mm	mm		mm	mm	kg	kg
1001.01	160	40	KP	15	45	0,92	70
1001.02	160	40	KP	20	45	0,92	70
1010.01	180	42	KP	15	45	1,22	100
1010.02	180	42	KP	20	45	1,22	100



Kolečka serie 1000

typ	mm	mm		mm	mm	kg	kg
1002.01	200	47	KP	20	50	1,30	120



Kolečka serie 1000

typ	mm	mm		mm	mm	kg	kg
41085.01	85	20/18	JL	12	32	0,18	60
41100.01	100	26/24	JL	12	42	0,30	80
41125.01	125	34/23	JL	15	42	0,52	110
41160.01	160	42/25	JL	20	55	1,04	140
41200.01	200	44/25	JL	20	60	1,65	200



Kolečka serie 1000

typ	mm	mm		mm	mm	kg	kg
1010.04	180	44	JL	20	60	1,22	160



Kolečka serie 1000

typ	mm	mm		mm	mm	kg	kg
1011.04	140	32	JL	20	50	0,85	130
1010.05	180	44	JL	20	60	1,22	160
1002.09	200	48	JL	20	60	1,57	180



> kovový disk



Kolečka serie 1000

typ	mm	mm		mm	mm	kg	kg
1015.01	220	42	KP	24	51	1,58	140
1015.02	220	42	KP	30	51	1,58	140



Kolečka serie 1000

typ	mm	mm		mm	mm	kg	kg
1015.03	220	42	JL	20	51	1,65	177



Kolečka serie 1000

typ	mm	mm		mm	mm	kg	kg
1005.14	250	80	JL	20	75	2,63	150



Kolečka serie 1000

typ	mm	mm		mm	mm	kg	kg
1003.12	250	80	JL	20	75	3,39	200



Kolečka serie 1000

typ	mm	mm		mm	mm	kg	kg
1003.10	250	80	GL	20	55	3,25	200
1003.11	250	80	GL	20	75	3,45	200



Kolečka serie 1000

typ	mm	mm		mm	mm	kg	kg
1003.09	250	80	JL	20	75	3,40	150

Legenda:

- KL - kluzné uložení
- JL - jehlové ložisko
- GL - kuličkové ložisko
- KP - kovové pouzdro

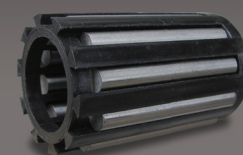



Kolečka serie 1000

typ	mm	mm		mm	mm	kg	kg
1024.01	208	75	GL	25	80	3,25	170
1003.08	250	80	GL	20	61	4,77	250
1003.04	250	80	GL	25	51,5	5,15	250
1023.02	300	100	GL	25	80	10,37	280

Zboží na objednávku



Kolečka serie 1000

typ	mm	mm		mm	mm	kg	kg
1003.03	250	52	KP	20	53	2,15	177
1003.01	250	52	KP	30	53	2,00	177



Kolečka serie 1000

typ	mm	mm		mm	mm	kg	kg
1003.02	250	52	JL	20	53	2,25	177



Kolečka serie 1000 - Kola 250mm ke stavební míchačce, osa 20mm

typ	mm	mm		mm	mm	kg	kg
1003.05	250	47	JL	20	60	2,77	200

Vhodné pro stavební míchačky



Kolečka serie 1000

typ	mm	mm		mm	mm	kg	kg
1003.06	250	47	GL	20	70	3,20	220
1003.07	250	47	GL	25	60	3,20	220

Vhodné pro stavební míchačky



Kolečka serie 1000

typ	mm	mm		mm	mm	kg	kg
1021.01	290	43	KP	30	45	2,70	150
1021.02	290	43	JL	20	45	2,72	150



> kovový disk



Kolečka serie 1000

typ	mm	mm		mm	mm	kg	kg
1023.01	300	55	KP	30	60	3,00	100



Kolečka serie 1000

typ	mm	mm		mm	mm	kg	kg
1023.03	300	70	JL	20	80	4,68	250



Kolečka serie 1000

typ	mm	mm		mm	mm	kg	kg
1023.04	300	45	JL	25	75	4,00	250



Kolečka serie 1000

typ	mm	mm		mm	mm	kg	kg
1006.01	320	75	KP	30	60	3,80	177



Kolečka serie 1000

typ	mm	mm		mm	mm	kg	kg
1006.02	320	75	JL	20	60	3,86	177



Kolečka serie 1000

typ	mm	mm		mm	mm	kg	kg
1016.02	350	73	KP	30	60	5,20	200
1016.03	350	73	JL	20	60	5,26	200

Legenda:

KL - kluzné uložení
 JL - jehlové ložisko
 GL - kuličkové ložisko



Kolečka serie 1000

typ	mm	mm		mm	mm	kg	kg
1007.01	370	74	KP	30	60	5,40	276



Kolečka serie 1000

typ	mm	mm		mm	mm	kg	kg
1007.02	370	74	JL	20	60	5,46	276



Kolečka serie 1000

typ	mm	mm		mm	mm	kg	kg
1019.09	400	100	KL	12	105	5,90	250
1019.05	400	100	KL	12	100	5,90	250
1019.06	400	100	KL	17	100	5,80	250
1019.07	400	100	KL	20	100	5,80	250
1019.03	400	100	JL	20	75	6,00	250
1019.18	400	100	KL	25	74	6,00	250



Kolečka serie 1000

typ	mm	mm		mm	mm	kg	kg
1019.12	400	101	GL	20	74	6,50	250
1019.13	400	101	GL	20	80	7,00	250
1019.15	400	101	GL	20	55	7,00	250
1019.17	400	101	GL	25	74	6,80	250

Kuličkové ložisko v kole.



Kolečka serie 1000

typ	mm	mm		mm	mm	kg	kg
1019.22	400	100	GL	20	55	8,00	250

Náhradní kolo ke stavebnímu kolečku s kuličkovým ložiskem včetně osy 20 mm, L = 400 mm.



Legenda:

- KL - kluzné uložení
- JL - jehlové ložisko
- GL - kuličkové ložisko
- KP - kovové pouzdro

> plastový disk



Kolečka serie 2000

typ	mm		mm	L mm	kg	kg
2017.01	80	KL	10	40	0,16	50



Kolečka serie 2000

typ	mm		mm	L mm	kg	kg
2009.01	100	KL	12	35	0,20	60



Kolečka serie 2000

typ	mm		mm	L mm	kg	kg
2009.02	100	KL	10	40	0,23	60



Kolečka serie 2000

typ	mm		mm	L mm	kg	kg
2010.01	125	KL	12	35	0,40	60



Kolečka serie 2000

typ	mm		mm	L mm	kg	kg
2006.01	140	KL	12	43	0,40	70
2006.02	140	KL	15	43	0,40	70
2006.03	140	KL	20	43	0,40	70



Kolečka serie 2000







typ	mm		mm	L mm	kg	kg
2015.01	140	KL	8	31	0,18	15

Kolo na nákupní tašku.











Kolečka serie 2000

 typ	 mm		 mm	 L mm	 kg	 kg
2005.01	160	KL	12	44	0,60	70
2005.02	160	KL	15	44	0,60	70
2005.03	160	KL	20	44	0,60	70









Kolečka serie 2000

 typ	 mm		 mm	 L mm	 kg	 kg
2005.07	160	KL	20	50	0,53	70









Kolečka serie 2000

 typ	 mm		 mm	 L mm	 kg	 kg
2007.04	180	KL	20	57	0,95	120









Kolečka serie 2000

 typ	 mm		 mm	 L mm	 kg	 kg
2007.01	180	KL	12	44	0,90	80
2007.02	180	KL	15	44	0,90	80
2007.03	180	KL	20	44	0,90	80



Kolečka serie 2000

 typ	 mm		 mm	 L mm	 kg	 kg
2008.08	200	KL	20	57	1,10	150



Kolečka serie 2000

 typ	 mm		 mm	 L mm	 kg	 kg
2008.11	200	KL	20	56	1,42	150

> plastový disk



Kolečka serie 2000

typ	mm		mm	L mm	kg	kg
2001.01	200	KL NOS	21,5	100	1,20	100



Kolečka serie 2000

typ	mm		mm	L mm	kg	kg
2008.01	200	KL	12	44	1,00	100
2008.02	200	KL	15	44	1,00	100



Kolečka serie 2000

typ	mm		mm	L mm	kg	kg
2016.01	250	KL	27	52	1,80	150



Kolečka serie 2000

typ	mm		mm	L mm	kg	kg
2012.03	260	KL	20	75	2,10	125



Kolečka serie 2000

typ	mm		mm	L mm	kg	kg
2012.04	260	JL	20	75	2,20	125



Kolečka serie 2000

typ	mm		mm	L mm	kg	kg
2101.01	150	KL	12,8	40	0,48	50
2102.01	175	KL	12,8	40	0,52	50

Kolečka na sekačku na trávu.



> plastová lehčená obruč, plastový disk



Kolečka s plastovou lehčenou obručí na plastovém disku serie 5000

typ	mm		mm	L mm	kg	kg
5001.01	300	KL	12	60	0,78	50
5002.01	240	KL	12	43	0,39	30



Kolečka s plastovou lehčenou obručí na plastovém disku serie 5000

typ	mm		mm	L mm	kg	kg
5013.01	250	KL	20	73	0,75	70
5013.02	250	JL	20	73	0,75	100



Kolečka s plastovou lehčenou obručí na plastovém disku serie 5000

typ	mm		mm	L mm	kg	kg
5015.01	200	KL	20	59	0,40	15



Kolečka s plastovou lehčenou obručí na plastovém disku serie 5000

typ	mm		mm	L mm	kg	kg
5012.01	190	KL	12	45	0,24	50
5012.02	190	KL	15	45	0,24	50
5012.03	190	KL	20	45	0,24	50



Kolečka s plastovou lehčenou obručí na plastovém disku serie 5000

typ	mm		mm	L mm	kg	kg
5004.01	145	KL	12	43	0,24	30
5004.02	145	KL	15	43	0,24	30
5004.03	145	KL	20	43	0,24	30
5005.01	160	KL	12	45	0,19	30
5005.02	160	KL	15	45	0,19	30
5005.03	160	KL	20	45	0,19	30
5006.01	180	KL	12	45	0,30	50
5006.02	180	KL	15	45	0,30	50
5006.03	180	KL	20	45	0,30	50
5011.01	200	KL	12	45	0,30	50
5011.02	200	KL	15	45	0,30	50
5011.03	200	KL	20	45	0,30	50



Kolečka s plastovou lehčenou obručí na plastovém disku serie 5000

typ	mm		mm	L mm	kg	kg
5014.01	130	KL	12	45	0,12	50
5014.02	130	KL	15	45	0,12	50
5014.03	130	KL	20	45	0,12	50

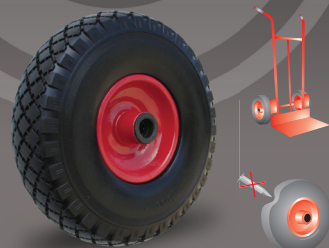

Nepropíchnutelné bezúdržbové kolo 260 mm

Kolečka s plastovou lehčenou obručí na kovovém disku serie 5000

typ	mm		mm	L mm	kg	kg
5016.01	260	JL	20	75	1,29	100



Kolečka zadní celohliníková serie 14000

typ	mm	mm		mm	mm	kg	kg
14082.06	82	70	GL	20/25	70	1	2000

Příklad použití: nízkozdvižný vozík - tandemové zadní kolo.



Kolečka zadní, polyamidový střed, polyuretanová obruč serie 14000

typ	mm	mm		mm	mm	kg	kg
14082.04	82	70	GL	20	70	0,50	510

Příklad použití: nízkozdvižný vozík - tandemové zadní kolo.



Kolečka zadní, polyamidový střed, polyuretanová obruč serie 14000

typ	mm	mm		mm	mm	kg	kg
14082.18	82	60	GL	20	60	0,47	510



Kolečka zadní polyamidová serie 14000

typ	mm	mm		mm	mm	kg	kg
14082.19	82	70	GL	20	70	0,48	500
14082.52	82	90	GL	20	90	0,55	500

Příklad použití: nízkozdvižný vozík - zadní kolo.



Kolečka zadní hliníkový střed, gumová obruč serie 14000

typ	mm	mm		mm	mm	kg	kg
14082.82	82	70	GL	20	70	0,7	400
14082.83	82	90	GL	20	90	0,8	400

Příklad použití: nízkozdvižný vozík - zadní kolo.

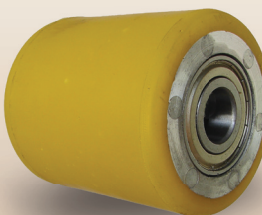

Kolečka zadní, hliníkový střed, polyuretanová obruč serie 14000

typ	mm	mm		mm	mm	kg	kg
14082.86	82	90	GL	20	90	0,85	700
14082.87	82	70	GL	20	70	0,73	600

Příklad použití: nízkozdvižný vozík - zadní kolo.



Kolečka určená k paletovacím vozíkům, jejichž plný sortiment naleznete na str. 95



Kolečka přední kola polyamidová serie 14000

typ	mm	mm		mm	L mm	L1 mm	kg	kg
14175.02	175	50	GL	20	55	42	0,80	500
14200.04	200	50	GL	20	57	40	1	800



Kolečka přední, hliníkový střed, gumová obruč serie 14000

typ	mm	mm		mm	mm	kg	kg
14180.08	180	50	GL	20	50	1,35	400
14200.02	200	50	GL	20	50	1,70	400



Kolečka přední, hliníkový střed, polyuretanová obruč serie 14000

typ	mm	mm		mm	L mm	L1 mm	kg	kg
14180.19	180	50	GL	20	50	42	1,15	400
14200.11	200	50	GL	20	50	42	1,17	400
14200.06	200	50	GL	20	50	-	1,35	800



> termoplastická gumová šedá obruč, polypropylenový disk, kovová konzola



Kolečka samostatná serie 40000

typ	mm	mm		mm	mm	kg	kg
40080.01	80	30	KL	10,1	35	0,900	100
40100.01	100	32	KL	10,1	35	0,117	100
40125.01	125	32	KL	10,1	35	0,178	100



Kolečka otočná s přírubou serie 40000

typ	mm	mm		mm	mm	mm	mm	mm	kg	kg
40080.05	80	30	KL	116	38	95 x 70	75/72x52/45	9	0,515	100
40100.05	100	32	KL	135	38	95 x 70	75/72x52/45	9	0,568	100
40125.05	125	32	KL	160	38	95 x 70	75/72x52/45	9	0,646	100



Kolečka otočná s přírubou s brzdou serie 40000

typ	mm	mm		mm	mm	mm	mm	mm	kg	kg
40080.08	80	30	KL	116	38	95 x 70	75/72x52/45	9	0,581	100
40100.08	100	32	KL	135	38	95 x 70	75/72x52/45	9	0,631	100
40125.08	125	32	KL	160	38	95 x 70	75/72x52/45	9	0,726	100



Kolečka pevná serie 40000

typ	mm	mm		mm	mm	mm	mm	mm	kg	kg
40080.15	80	30	KL	116	95 x 70	75/72x52/45	9	0,399	100	
40100.15	100	32	KL	135	95 x 70	75/72x52/45	9	0,498	100	
40125.15	125	32	KL	160	95 x 70	75/72x52/45	9	0,572	100	



Kolečka otočná s otvorem serie 40000

typ	mm	mm		mm	mm	mm	mm	mm	kg	kg
40080.21	80	30	KL	116	38	11	0,456	100		
40100.21	100	32	KL	135	38	11	0,508	100		
40125.21	125	32	KL	160	40	11	0,582	100		



Kolečka otočná s otvorem s brzdou serie 40000

typ	mm	mm		mm	mm	mm	mm	mm	kg	kg
40080.22	80	30	KL	116	38	11	0,521	100		
40100.22	100	32	KL	135	38	11	0,574	100		
40125.22	125	32	KL	160	40	11	0,663	100		

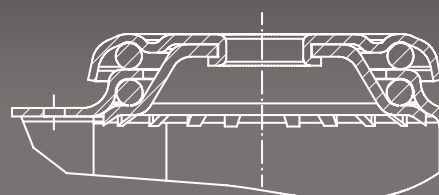

> kolečka

> kolečka otočná přístrojová > 100 kg > serie 40000

> termoplastická gumová šedá obruč, polypropylenový disk, kovová konzola



Kolečka otočná s hladkým čepem serie 40000

typ	mm	mm		mm	mm	mm	mm	kg	kg
40080.44	80	30	KL	116	38	20	45	0,593	100
40100.44	100	32	KL	135	38	20	45	0,645	100
40125.44	125	32	KL	160	40	20	45	0,719	100



Kolečka otočná s hladkým čepem s brzdou včetně brzdy otoče serie 40000

typ	mm	mm		mm	mm	mm	mm	kg	kg
40080.45	80	30	KL	116	38	20	45	0,658	100
40100.45	100	32	KL	135	38	20	45	0,714	100
40125.45	125	32	KL	160	40	20	45	0,800	100



Kolečka pevná se středovým otvorem serie 40000

typ	mm	mm		mm	mm	mm	kg	kg
40080.79	80	30	KL	116	95 x 70	10 x 10	0,399	100
40100.79	100	32	KL	135	95 x 70	10 x 10	0,498	100
40125.79	125	32	KL	160	95 x 70	10 x 10	0,572	100

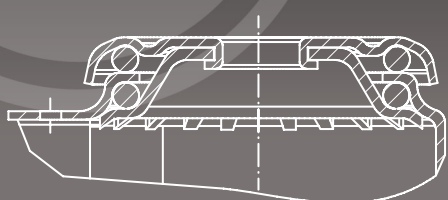

> šedá pryžová obruč, plastový disk, kovová konzola, protivláknový kryt



Kolečka otočná s přírubou serie 42000

typ	mm		mm	mm	mm	mm	mm	kg	kg
42050.05	50	KL	70	25	50 x 50	35 x 35	6	0,40	55
42075.05	75	KL	96	32	65 x 65	47 x 47	6	0,60	75
42100.05	100	KL	135	35	76 x 76	57 x 57	8	0,90	85
42125.05	125	KL	160	44	76 x 76	57 x 57	8	1,00	95



Kolečka otočná s otvorem serie 42000

typ	mm		mm	mm	mm	mm	mm	kg	kg
42050.21	50	KL	70	22	10,5	40	0,40	55	
42075.21	75	KL	96	33	10,5	48	0,60	75	
42100.21	100	KL	135	40	10,5	55	0,90	85	
42125.21	125	KL	160	42	10,5	55	1,00	95	



Kolečka otočná s čepem se závitem serie 42000

typ	mm		mm	mm	mm	mm	mm	kg	kg
42050.11	50	KL	70	22	M 12	30	40	0,40	55
42075.11	75	KL	96	33	M 12	30	48	0,60	75
42100.11	100	KL	135	40	M 12	30	55	0,90	85
42125.11	125	KL	160	42	M 12	30	55	1,00	95

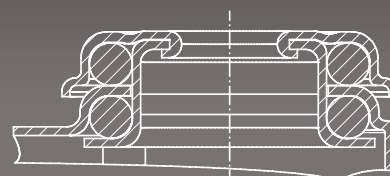



Kolečka samostatná serie 59000

typ	mm		mm	L mm	kg	kg
59050.02	50	KL	8	23	0,80	30
59065.02	65	KL	8	25	0,10	35
59075.02	75	KL	10	25	0,14	40
59100.02	100	KL	12	31	0,23	55
59125.02	125	KL	12	31	0,35	60



Kolečka otočná s přírubou serie 59000

typ	mm		mm	mm	mm	mm	mm	kg	kg
59050.05	50	KL	72	25	50 x 50	36 x 36	6,2	0,22	30
59065.05	65	KL	94	30	65 x 65	49 x 49	6,2	0,35	35
59075.05	75	KL	104	33	65 x 65	49 x 49	6,2	0,38	40
59100.05	100	KL	134	38	75 x 75	55 x 55	8,5	0,69	55
59125.05	125	KL	161	33	75 x 75	55 x 55	8,5	0,84	60



Kolečka otočná s přírubou s brzdou serie 59000

typ	mm		mm	mm	mm	mm	mm	kg	kg
59050.08	50	KL	72	25	50 x 50	36 x 36	6,2	0,26	30
59065.08	65	KL	94	30	65 x 65	49 x 49	6,2	0,40	35
59075.08	75	KL	104	33	65 x 65	49 x 49	6,2	0,44	40
59100.08	100	KL	134	38	75 x 75	55 x 55	8,5	0,79	55
59125.08	125	KL	161	33	75 x 75	55 x 55	8,5	0,93	60



Kolečka pevná serie 59000

typ	mm		mm	mm	mm	mm	kg	kg
59050.15	50	KL	72	65 x 50	45 x 33	6,5	0,12	30
59065.15	65	KL	94	100 x 59	81 x 40	8,5	0,25	35
59075.15	75	KL	104	100 x 59	81 x 40	8,5	0,29	40
59100.15	100	KL	134	100 x 59	81 x 40	8,5	0,50	55
59125.15	125	KL	161	100 x 59	81 x 40	8,5	0,67	60



Kolečka otočná s otvorem serie 59000

typ	mm		mm	mm	mm	kg	kg
59050.21	50	KL	70	25	10,5	0,17	30
59065.21	65	KL	91	30	10,5	0,28	35
59075.21	75	KL	101	33	10,5	0,32	40
59100.21	100	KL	132	38	12,9	0,57	55
59125.21	125	KL	158	33	12,9	0,74	60



Kolečka otočná s otvorem s brzdou serie 59000

typ	mm		mm	mm	mm	kg	kg
59050.22	50	KL	70	25	10,5	0,20	30
59065.22	65	KL	91	30	10,5	0,33	35
59075.22	75	KL	101	33	10,5	0,37	40
59100.22	100	KL	132	38	12,9	0,69	55
59125.22	125	KL	158	33	12,9	0,82	60

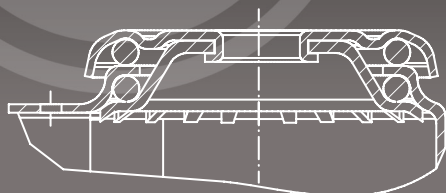

> celopryžová černá



Kolečka otočná s přírubou serie 43000

typ	mm	KL	mm	mm	mm	mm	mm	kg	kg
43050.05	50	KL	65	19	57 x 50	47 x 35	5,5	0,20	30
43060.05	60	KL	80	25	65 x 53	50 x 40	6,5	0,30	35



Kolečka pevná serie 43000

typ	mm	KL	mm	mm	mm	mm	kg	kg
43050.15	50	KL	65	57 x 50	47 x 35	5,5	0,20	30



Kolečka otočná s otvorem serie 43000

typ	mm	KL	mm	mm	mm	mm	kg	kg
43060.21	60	KL	80	13	9	34	0,30	35



Kolečka otočná s čepem se závitem serie 43000

typ	mm	KL	mm	mm	mm	mm	mm	kg	kg
43050.11	50	KL	65	23	M 10	25	33	0,20	30



Kolečka otočná s přírubou(s brzdou) serie 44000

typ	mm		mm	mm	mm	mm	kg	kg
44040.05	40	KL	54	38 x 38	26 x 26	5	0,25	20
44050.05	50	KL	64	38 x 38	26 x 26	5	0,37	20

Balení: 2 ks. s brzdou + 2 ks. bez brzdy.



Kolečka otočná s hladkým čepem serie 44000

typ	mm		mm	mm	mm	kg	kg
44050.19	50	KL	60	8	38	0,35	20



Kolečka otočná s hladkým čepem s brzdou serie 44000

typ	mm		mm	mm	mm	kg	kg
44050.20	50	KL	60	11	22	0,35	20



Kolečka otočná s čepem se závitem serie 44000

typ	mm		mm	mm	mm	kg	kg
44050.11	50	KL	60	M 10	15	0,37	20



> černá pryžová obruč, kovový disk, kovová konzola, protivláknový kryt



Kolečka samostatná serie 41000

typ	mm		mm	L mm	kg	kg
41075.01	75	JL	12	32	0,12	50
41080.01	80	JL	12	40	0,13	50
41085.01	85	JL	12	32	0,18	60
41100.01	100	JL	12	42	0,30	80
41125.01	125	JL	15	42	0,52	110
41160.01	160	JL	20	55	1,04	140
41200.01	200	JL	20	60	1,65	200



Kolečka otočná s přírubou serie 41000

typ	mm		mm	mm	mm	mm	mm	kg	kg
41075.04	85	JL	99	30	82 x 68	61 x 47	8	0,43	50
41080.04	80	JL	107	35	104 x 80	77 x 57	8	0,55	50
41085.04	85	JL	100	35	103 x 82	77 x 57	8	0,90	60
41100.04	100	JL	120	35	103 x 82	80 x 60	8	1,00	80
41125.04	125	JL	150	40	103 x 82	80 x 60	8	1,30	110
41160.04	160	JL	185	45	135 x 105	105 x 75	11	1,95	140
41200.04	200	JL	235	60	135 x 105	105 x 75	11	2,45	150



Kolečka otočná s přírubou s brzdou serie 41000

typ	mm		mm	mm	mm	mm	mm	kg	kg
41075.07	75	JL	99	30	82 x 68	61 x 47	8	0,50	50
41080.07	80	JL	107	35	104 x 80	77 x 57	8	0,60	50
41085.07	85	JL	100	35	103 x 82	77 x 57	8	0,90	60
41100.07	100	JL	120	35	103 x 82	80 x 60	8	1,00	80
41125.07	125	JL	150	40	103 x 82	80 x 60	8	1,30	110
41160.07	160	JL	185	45	135 x 105	105 x 75	11	2,35	140
41200.07	200	JL	235	60	135 x 105	105 x 75	11	3,10	150



Kolečka pevná serie 41000

typ	mm		mm	mm	mm	mm	kg	kg
41075.14	75	JL	99	82 x 68	61 x 47	8	0,22	50
41080.14	80	JL	107	104 x 80	77 x 57	8	0,42	50
41085.14	85	JL	100	103 x 82	77 x 57	8	0,60	60
41100.14	100	JL	120	103 x 82	80 x 60	8	0,75	80
41125.14	125	JL	150	103 x 82	80 x 60	8	1,10	110
41160.14	160	JL	185	135 x 105	105 x 75	11	1,95	140
41200.14	200	JL	235	135 x 105	105 x 75	11	2,78	150

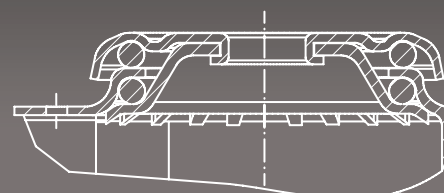

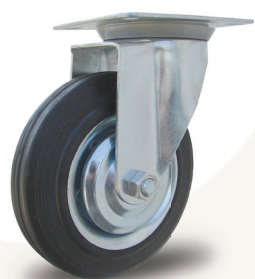

Kolečka otočná s přírubou serie 58000

typ	mm		mm	mm	mm	mm	mm	kg	kg
58085.04	80	JL	105	35	102 x 84	80 x 60	9	0,57	50
58100.04	100	JL	130	39	102 x 84	80 x 60	9	0,82	60
58125.04	125	JL	155	35	102 x 84	80 x 60	9	1,08	100
58160.04	160	JL	195	48	135 x 106	105 x 75	11	2,10	130
58200.04	200	JL	235	49	135 x 106	105 x 75	11	2,78	150



Kolečka otočná s přírubou s brzdou serie 58000

typ	mm		mm	mm	mm	mm	mm	kg	kg
58085.07	85	JL	105	35	102 x 84	80 x 60	9	0,68	50
58100.07	100	JL	130	39	102 x 84	80 x 60	9	0,97	60
58125.07	125	JL	155	35	102 x 84	80 x 60	9	1,25	100
58160.07	160	JL	195	48	135 x 106	105 x 75	11	2,41	130
58200.07	200	JL	235	49	135 x 106	105 x 75	11	3,21	150



Kolečka pevná serie 58000

typ	mm		mm	mm	mm	mm	mm	kg	kg
58085.14	85	JL	105	102 x 84	80 x 60	9	0,47	50	
58100.14	100	JL	130	102 x 84	80 x 60	9	0,66	60	
58125.14	125	JL	155	102 x 84	80 x 60	9	0,92	100	
58160.14	160	JL	195	135 x 106	105 x 75	11	1,90	130	
58200.14	200	JL	235	135 x 106	105 x 75	11	2,49	150	

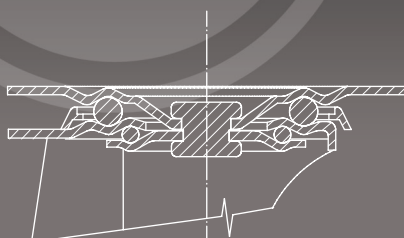

> černá pryžová obruč, kovový disk, kovová konzola samostatná



Kolečka samostatná serie 31000

typ	mm	mm		mm	L mm	kg	kg
31100.01	100	38	JL	15	43	0,40	90
31125.01	125	38	JL	15	43	0,60	100
31160.01	160	45	JL	20	59	1,34	205
31200.01	200	50	JL	20	59	1,98	205



Kolečka otočná s přírubou serie 31000

typ	mm	mm		mm	mm	mm	mm	mm	kg	kg
31100.04	100	38	JL	128	39	105 x 85	80 x 60	9	1,08	90
31125.04	125	38	JL	151	44	105 x 85	80 x 60	9	1,32	100
31160.04	160	45	JL	201	49	135 x 110	105 x 80/75	11	2,60	205
31200.04	200	50	JL	240	55	135 x 110	105 x 80/75	11	3,40	205



Kolečka otočná s přírubou a brzdou včetně brzdy otoče serie 31000

typ	mm	mm		mm	mm	mm	mm	mm	kg	kg
31160.69	160	45	JL	201	49	135 x 110	105 x 80/75	11	2,60	205
31200.69	200	50	JL	240	55	135 x 110	105 x 80/75	11	3,40	205



Kolečka pevná serie 31000

typ	mm	mm		mm	mm	mm	mm	kg	kg
31100.14	100	38	JL	128	105 x 85	80 x 60	9	0,90	90
31125.14	125	38	JL	151	105 x 85	80 x 60	9	1,10	100
31160.14	160	45	JL	201	135 x 110	105 x 80/75	11	2,37	205
31200.14	200	50	JL	240	135 x 110	105 x 80/75	11	3,15	205



Kolečka otočná s otvorem serie 31000

typ	mm	mm		mm	mm	mm	kg	kg
31100.23	100	38	JL	125	39	12,5	0,90	90
31125.23	125	38	JL	147	44	12,5	1,20	100
31160.23	160	45	JL	193	49	12,5	2,60	205
31200.23	200	50	JL	232	55	12,5	3,30	205



Kolečka otočná s otvorem s brzdou včetně brzdy otoče serie 31000

typ	mm	mm		mm	mm	mm	kg	kg
31160.71	160	45	JL	193	49	12,5	2,60	205
31200.71	200	50	JL	232	55	12,5	3,30	205

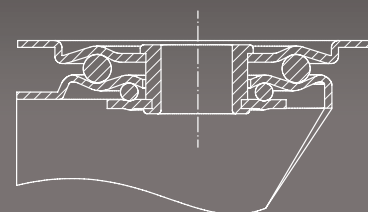



Kolečka otočná s hladkým čepem serie 31000

typ	mm	mm		mm	mm	mm	mm	kg	kg
31100.64	100	38	JL	125	39	22	45	0,90	90
31125.64	125	38	JL	147	44	22	45	1,20	100
31160.64	160	45	JL	193	49	27	65	2,60	205
31200.64	200	50	JL	232	55	27	65	3,30	205



Kolečka otočná kola s hladkým čepem s brzdou včetně brzdy otoče serie 31000

typ	mm	mm		mm	mm	mm	mm	kg	kg
31160.75	160	45	JL	193	49	27	65	2,60	205
31200.75	200	50	JL	232	55	27	65	3,30	205



Kolečka otočná s přírubou s brzdou serie 31000

typ	mm	mm		mm	mm	mm	mm	mm	kg	kg
31100.07	100	38	JL	128	39	105 x 85	80 x 60	9	1,80	90
31125.07	125	38	JL	151	44	105 x 85	80 x 60	9	1,42	100
31160.07	160	45	JL	201	49	135 x 110	105 x 80/75	11	2,60	205
31200.07	200	50	JL	240	55	135 x 110	105 x 80/75	11	3,40	205



> šedá pryž, kovový disk, kovová konzola



Kolečka samostatná serie 64000

typ	mm		mm	L mm	kg	kg
64080.01	80	JL	12	37	0,40	60
64100.01	100	JL	12	37	0,60	80
64125.01	125	JL	15	47	0,80	140
64160.01	160	JL	20	57	1,00	160
64200.01	200	JL	20	57	1,60	205



Kolečka otočná s přírubou serie 64000

typ	mm		mm	mm	mm	mm	mm	kg	kg
64125.04	125	JL	159	40	113 x 93	80 x 60	9	1,50	140
64160.04	160	JL	195	47	138 x 114	105 x 80/75	11	2,50	160
64200.04	200	JL	240	51	138 x 114	105 x 80/75	11	3,50	205



Kolečka otočná s přírubou s brzdou serie 64000

typ	mm		mm	mm	mm	mm	mm	kg	kg
64125.07	125	JL	159	40	113 x 93	80 x 60	9	2,00	140
64160.07	160	JL	195	47	138 x 114	105 x 80/75	11	2,85	160
64200.07	200	JL	240	51	138 x 114	105 x 80/75	11	4,00	205



Kolečka pevná serie 64000

typ	mm		mm	mm	mm	mm	kg	kg
64125.14	125	JL	159	113 x 93	80 x 60	9	1,00	140
64160.14	160	JL	195	138 x 114	105 x 80/75	11	2,00	160
64200.14	200	JL	240	138 x 114	105 x 80/75	11	3,00	205

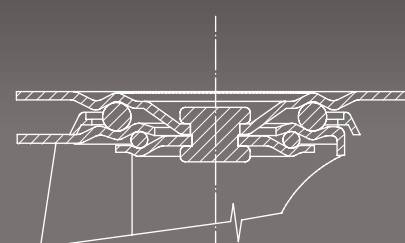



Kolečka samostatná serie 37000

typ	mm		mm	L mm	kg	kg
37125.03	125	GL	20	60	0,85	250
37160.03	160	GL	20	60	1,20	300
37160.98	160	GL	25	60	1,20	300
37180.03	180	GL	20	50	1,40	350
37180.98	180	GL	25	50	1,40	350
37200.03	200	GL	20	50	1,75	400
37200.98	200	GL	25	50	1,75	400
37250.03	250	GL	25	82	1,90	600
37300.03	300	GL	25	82	2,10	700



Kolečka otočná s přírubou serie 37000

typ	mm	mm		mm	mm	mm	mm	mm	kg	kg
37125.06	125	50	GL	160	53	135 x 110	105 x 80/75	11	2,10	250
37160.06	160	50	GL	200	49	135 x 110	105 x 80/75	11	2,60	300
37180.06	180	50	GL	230	55	135 x 110	105 x 80/75	11	3,00	350
37200.06	200	50	GL	240	55	135 x 110	105 x 80/75	11	3,40	400
37250.06	250	76	GL	303	76	195 x 160	160 x 120	14,5	4,10	400



Kolečka otočná s přírubou s brzdou serie 37000

typ	mm	mm		mm	mm	mm	mm	mm	kg	kg
37125.09	125	50	GL	160	53	135 x 110	105 x 80/75	11	2,30	250
37160.09	160	50	GL	200	49	135 x 110	105 x 80/75	11	2,90	300
37180.09	180	50	GL	230	55	135 x 110	105 x 80/75	11	3,30	350
37200.09	200	50	GL	240	55	135 x 110	105 x 80/75	11	3,70	400



Kolečka pevná serie 37000

typ	mm	mm		mm	mm	mm	mm	mm	kg	kg
37125.16	125	50	GL	160	135 x 110	105 x 80/75	11	1,80	250	
37160.16	160	50	GL	200	135 x 110	105 x 80/75	11	2,16	300	
37180.16	180	50	GL	230	135 x 110	105 x 80/75	11	2,57	350	
37200.16	200	50	GL	240	135 x 110	105 x 80/75	11	2,96	400	
37250.16	250	76	GL	303	195 x 160	160 x 120	14,5	3,10	400	

> elastická pryžová obruč, hliníkový střed, kovová konzola



Kolečka otočná s hladkým čepem serie 37000

typ	mm	mm		mm	mm	mm	mm	kg	kg
37125.47	125	50	GL	155	53	27	65	2,40	250
37160.47	160	50	GL	195	49	27	65	2,85	300



Kolečka otočná s hladkým čepem s brzdou serie 37000

typ	mm	mm		mm	mm	mm	mm	kg	kg
37125.48	125	50	GL	155	53	27	65	2,95	250
37160.48	160	50	GL	195	49	27	65	3,29	300



Kolečka otočná s trubkovým čepem serie 37000

typ	mm	mm		mm	mm	mm	mm	kg	kg
37125.62	125	50	GL	155	53	38	143	2,73	250
37160.62	160	50	GL	195	49	38	143	3,17	300
37180.62	180	50	GL	225	55	38	143	3,46	350
37200.62	200	50	GL	235	55	38	143	3,80	400



Kolečka otočná s trubkovým čepem s brzdou serie 37000

typ	mm	mm		mm	mm	mm	mm	kg	kg
37125.63	125	50	GL	155	53	38	143	3,20	250
37160.63	160	50	GL	195	49	38	143	3,50	300
37180.63	180	50	GL	225	55	38	143	3,87	350
37200.63	200	50	GL	235	55	38	143	4,10	400



Kolečka samostatná serie 45000

typ	mm		mm	L mm	kg	kg
45080.01	80	JL	15	40	0,12	100
45100.01	100	JL	15	40	0,15	100
45125.01	125	JL	15	50	0,33	150
45140.01	140	JL	15	50	0,30	150
45160.01	160	JL	20	60	0,60	160
45200.01	200	JL	20	60	0,75	180



Kolečka otočná s přírubou serie 45000

typ	mm		mm	mm	mm	kg	kg
45080.04	80	JL	104	82	60 x 80	0,68	100
45100.04	100	JL	123	91	60 x 80	0,73	100
45125.04	125	JL	168	112	80 x 107	1,40	150
45140.04	140	JL	173	116	80 x 107	1,45	150
45160.04	160	JL	190	133	80 x 107	1,85	160
45200.04	200	JL	235	154	80 x 107	2,05	180



Kolečka otočná s přírubou s brzdou serie 45000

typ	mm		mm	mm	mm	kg	kg
45080.07	80	JL	104	82	60 x 80	0,72	100
45100.07	100	JL	123	91	60 x 80	0,77	100
45125.07	125	JL	168	112	80 x 107	1,75	150
45140.07	140	JL	173	116	80 x 107	1,80	150
45160.07	160	JL	190	133	80 x 107	2,20	160
45200.07	200	JL	235	154	80 x 107	2,48	180

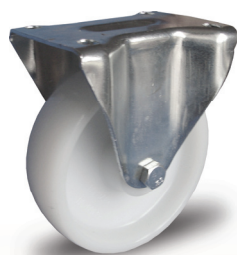

Kolečka pevná serie 45000

typ	mm		mm	mm	kg	kg
45080.14	80	JL	104	60 x 80	0,44	100
45100.14	100	JL	123	60 x 80	0,50	100
45125.14	125	JL	168	80 x 107	0,92	150
45140.14	140	JL	173	80 x 107	0,97	150
45160.14	160	JL	190	80 x 107	1,30	160
45200.14	200	JL	235	80 x 107	1,80	180



Kolečka otočná s otvorem serie 45000



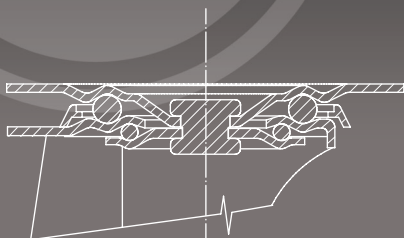





typ	mm		mm	mm	mm	kg	kg
45080.23	80	JL	104	83	12,5	0,50	100
45100.23	100	JL	122	92	12,5	0,58	100
45125.23	125	JL	149	97	12,5	0,82	100
45140.23	140	JL	165	116	16	1,23	150
45160.23	160	JL	181	130	16	1,45	160
45200.23	200	JL	227	153	16	1,83	180



> polyamidové kolo, kovová konzola











Kolečka otočná s hladkým čepem serie 45000

 typ	 mm		 mm	 mm	 mm	 kg	 kg
45080.64	80	JL	101	83	M10	0,65	60
45100.64	100	JL	122	92	M10	0,73	60
45125.64	125	JL	161	111	24	1,53	120
45140.64	140	JL	168	116	25	1,58	150
45160.64	160	JL	181	130	25	1,65	160
45200.64	200	JL	227	153	25	2,28	180



Kolečka otočná s hladkým čepem s brzdou serie 45000

 typ	 mm		 mm	 mm	 mm	 kg	 kg
45125.66	125	JL	161	111	25	1,88	120
45140.66	140	JL	168	116	25	1,94	150
45160.66	160	JL	181	130	25	2,07	160
45200.66	200	JL	227	153	25	2,63	180



Kolečka samostatná serie 49000

typ	mm		mm	L mm	kg	kg
49080.01	80	JL	12	40	0,13	100
49100.01	100	JL	12	40	0,16	100
49125.01	125	JL	15	50	0,37	150
49160.01	160	JL	20	60	0,78	200
49200.03	200	GL	20	60	1,00	300



Kolečka otočná s přírubou serie 49000

typ	mm		mm	mm	mm	kg	kg
49080.04	80	JL	104	74	60 x 80	0,63	80
49100.04	100	JL	123	86	60 x 80	0,66	80
49125.04	125	JL	167	110	80 x 107	1,45	150
49160.04	160	JL	188	129	80 x 107	2,05	200
49160.06	160	GL	188	127	80 x 107	2,40	300
49200.06	200	GL	235	147	80 x 107	2,70	300



Kolečka otočná s přírubou a brzdou serie 49000

typ	mm		mm	mm	mm	kg	kg
49080.07	80	JL	104	82	60 x 80	0,75	80
49100.07	100	JL	123	91	60 x 80	0,78	80
49125.07	125	JL	167	110	80 x 107	1,80	150
49160.09	160	GL	188	127	80 x 107	2,80	300
49200.09	200	GL	235	147	80 x 107	3,15	300



Kolečka pevná serie 49000

typ	mm		mm	mm	kg	kg
49080.14	80	JL	104	60 x 80	0,42	100
49100.14	100	JL	123	60 x 80	0,45	100
49125.14	125	JL	167	80 x 107	1,00	150
49160.14	160	JL	188	80 x 107	1,20	200
49160.16	160	GL	188	80 x 107	1,50	300
49200.16	200	GL	235	80 x 107	1,85	300



Kolečka otočná kola s otvorem serie 49000

typ	mm		mm	mm	mm	kg	kg
49080.23	80	JL	100	82	12,5	0,51	100
49100.23	100	JL	121	91	12,5	0,59	100
49125.23	125	JL	148	96	12,5	0,86	100
49160.23	160	JL	181	130	16	1,44	150

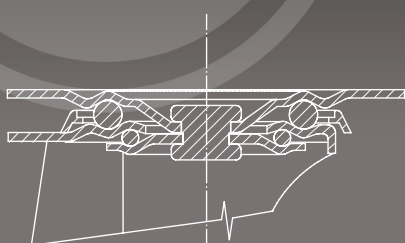

> polyuretanová na polyamidovém středu PU/PA



Kolečka otočná s hladkým čepem serie 49000

typ	mm		mm	mm	mm	kg	kg
49080.64	80	JL	100	82	M10	0,66	60
49100.64	100	JL	120	91	M10	0,74	60
49125.64	125	JL	162	110	25	1,57	150
49160.64	160	JL	181	130	25	1,65	180

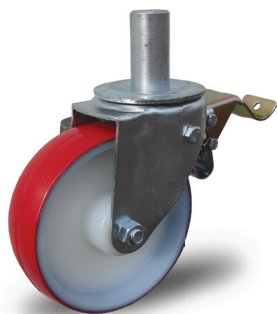

Kolečka otočná s hladkým čepem s brzdou serie 49000

typ	mm		mm	mm	mm	kg	kg
49080.66	80	JL	100	82	M10	0,71	60
49100.66	100	JL	120	91	M10	0,79	60
49125.66	125	JL	162	110	25	1,92	150
49160.66	160	JL	181	130	25	2,06	180



Legenda:

JL - jehlové ložisko
GL - kuličkové ložisko



Kolečka solo serie 55000

typ	mm	GL	mm	L mm	kg	kg
55100.03	100	GL	15	50	0,32	150
55125.03	125	GL	15	50	0,40	250
55140.03	140	GL	20	50	0,85	250
55150.03	150	GL	20	60	0,90	400
55160.03	160	GL	20	60	1,05	400
55180.03	180	GL	20	60	1,20	450
55200.03	200	GL	20	60	1,40	500
55250.03	250	GL	20	60	2,50	500



Kolečka otočná s přírubou serie 55000

typ	mm	mm	GL	mm	mm	mm	mm	mm	kg	kg
55125.06	125	42	GL	165	110	140 x 110	107 x 80	11	1,45	200
55140.06	140	40	GL	173	116	140 x 110	107 x 80	11	1,87	200
55160.06	160	47	GL	188	127	140 x 110	107 x 80	11	2,60	300
55180.06	180	47	GL	222	152	140 x 110	107 x 80	11	2,40	250
55200.06	200	47	GL	232	145	140 x 110	107 x 80	11	3,27	300
55250.06	250	47	GL	284	188	140 x 110	107 x 80	11	3,65	300



Kolečka otočná s brzdou včetně brzdy otoče 55000

typ	mm	mm	GL	mm	mm	mm	mm	mm	kg	kg
55125.09	125	42	GL	165	110	140 x 110	107 x 80	11	1,90	200
55140.09	140	40	GL	173	116	140 x 110	107 x 80	11	2,24	200
55160.09	160	47	GL	188	127	140 x 110	107 x 80	11	3,13	300
55180.09	180	47	GL	222	152	140 x 110	107 x 80	11	3,83	250
55200.09	200	47	GL	232	145	140 x 110	107 x 80	11	3,55	300



Kolečka pevná s konzolou serie 55000

typ	mm	mm	GL	mm	mm	mm	mm	mm	kg	kg
55125.16	125	42	GL	165	140 x 110	107 x 80	11	1,86	200	200
55140.16	140	40	GL	173	140 x 110	107 x 80	11	1,50	200	200
55160.16	160	47	GL	188	140 x 110	107 x 80	11	1,82	300	300
55180.16	180	47	GL	222	140 x 110	107 x 80	11	2,18	250	250
55200.16	200	47	GL	232	140 x 110	107 x 80	11	2,68	300	300
55250.16	250	47	GL	284	140 x 110	107 x 80	11	3,00	300	300

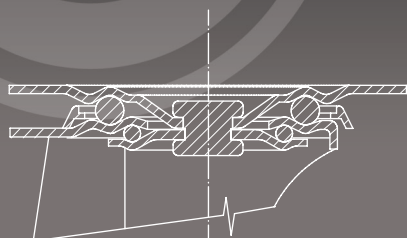

> polyuretanová obruč, hliníkový střed



Kolečka samostatná serie 35000

typ	mm		mm	L mm	L1 mm	kg	kg
35160.03	160	GL	20	50	-	0,40	600
35175.03	175	GL	20	42	8	0,60	650
35200.03	200	GL	20	50	-	1,34	800
35250.03	250	GL	25	82	-	1,35	1500
35300.03	300	GL	25	82	-	1,35	1800



Kolečka otočná s přírubou serie 35000

typ	mm	mm		mm	mm	mm	mm	mm	kg	kg
35160.06	160	50	GL	205	52	135 x 110	105 x 75	11	3,54	600
35160.99	160	50	GL	210	55	135 x 110	105 x 75	11	3,62	600
35175.06	175	50	GL	233	52	135 x 110	105 x 75	11	3,64	600
35200.06	200	50	GL	245	61	135 x 110	105 x 75	11	3,78	600
35200.99	200	50	GL	245	52	135 x 110	105 x 75	11	3,86	800
35250.06	250	76	GL	310	72	195 x 160	160 x 120	15	3,92	1500

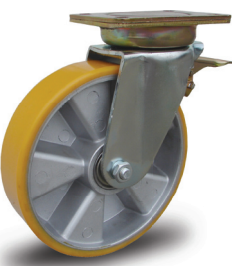

Kolečka otočná s brzdou včetně brzdy otoče serie 35000

typ	mm	mm		mm	mm	mm	mm	mm	kg	kg
35160.09	160	50	GL	205	52	135 x 110	105 x 75	11	3,70	600
35160.94	160	50	GL	210	55	135 x 110	105 x 75	11	3,78	600
35175.09	175	50	GL	233	52	135 x 110	105 x 75	11	3,80	600
35200.09	200	50	GL	245	61	135 x 110	105 x 75	11	3,88	600
35200.94	200	50	GL	245	61	135 x 110	105 x 75	11	3,90	800
35250.09	250	76	GL	310	72	195 x 160	160 x 120	15	3,98	1500



Kolečka pevná serie 35000

typ	mm	mm		mm	mm	mm	mm	mm	kg	kg
35160.16	160	50	GL	205	52	135 x 110	105 x 75	11	2,30	600
35160.97	160	50	GL	210	55	135 x 110	105 x 75	11	2,40	600
35175.16	175	50	GL	233	52	135 x 110	105 x 75	11	2,68	600
35200.16	200	50	GL	245	61	135 x 110	105 x 75	11	2,86	600
35200.97	200	50	GL	245	61	135 x 110	105 x 75	11	3,42	800
35250.16	250	76	GL	310	72	195 x 160	160 x 120	15	3,52	1500

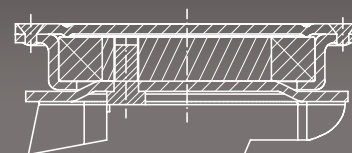
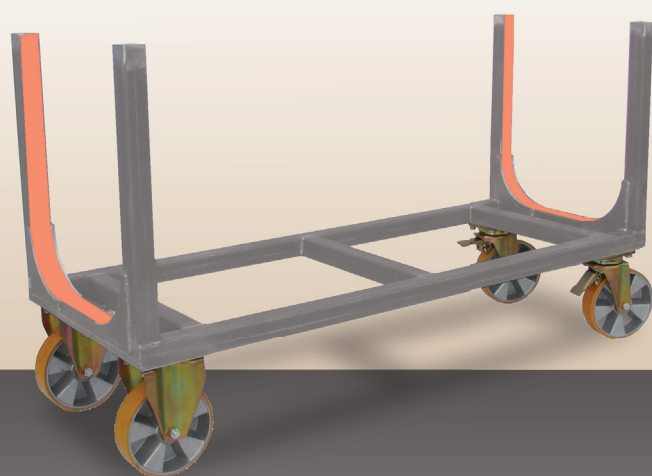



Kolečka samostatná serie 39000

typ	mm	mm		mm	L mm	kg	kg
39180.03	180	50	GL	20	50	2,57	850
39200.03	200	60	GL	20	60	4,10	1000
39250.03	250	75	GL	25	82	8,4	1600
39300.03	300	90	GL	30	100	16,50	2500
39400.03	400	100	GL	50	120	35	3500

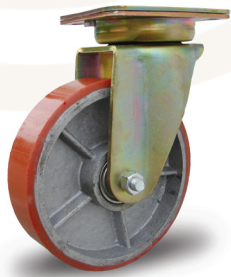

Kolečka otočná s přírubou serie 39000

typ	mm	mm		mm	mm	mm	mm	mm	kg	kg
39180.06	180	50	GL	240	50	135 x 110	105 x 80/75	11	5,16	800
39200.06	200	50	GL	245	50	135 x 110	105 x 80/75	11	11	950
39250.06	250	75	GL	310	72	195 x 160	160 x 120	15	15,3	1500

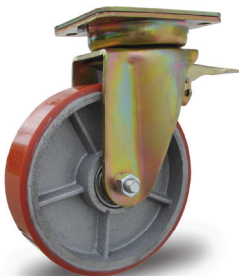

Kolečka otočná s brzdou vč. brzdy otoče serie 39000

typ	mm	mm		mm	mm	mm	mm	mm	kg	kg
39180.09	180	50	GL	240	50	135 x 110	105 x 80/75	11	5,49	800
39200.09	200	50	GL	245	50	135 x 110	105 x 80/75	11	12,10	950
39250.09	250	75	GL	310	72	195 x 160	160 x 120	15	16,4	1500



Kolečka pevná serie 39000

typ	mm	mm		mm	mm	mm	mm	kg	kg
39180.16	180	50	GL	240	135 x 110	105 x 80/75	11	4,43	800
39200.16	200	50	GL	245	135 x 110	105 x 80/75	11	10,2	950
39250.16	250	75	GL	310	195 x 160	160 x 120	15	14,50	1500

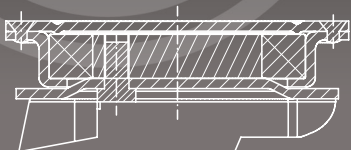

> KOV/KOV - vysoká nosnost



Kolečka samostatná serie 48000

typ	mm	mm		mm	mm	kg	kg
48080.03	80	46	GL	20	52	1,40	600
48100.03	100	46	GL	20	52	2,10	600
48125.03	125	46	GL	20	52	2,90	800
48160.03	160	51	GL	20	60	4,50	1000
48200.03	200	51	GL	20	60	6,05	1200



Kolečka otočná s přírubou serie 48000

typ	mm		mm	mm	mm	mm	kg	kg
48080.06	80	GL	134	78	60 x 80	11	3,60	600
48100.06	100	GL	154	78	60 x 80	11	4,40	600
48125.06	125	GL	174	104	80 x 107	11	6,10	800
48160.06	160	GL	220	118	80 x 107	11	8,25	1000
48200.06	200	GL	260	142	80 x 107	11	9,90	1200

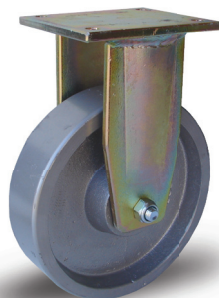

Kolečka pevná serie 48000

typ	mm		mm	mm	mm	kg	kg
48080.16	80	GL	134	60 x 80	11	2,65	600
48100.16	100	GL	154	60 x 80	11	3,40	600
48125.16	125	GL	174	80 x 107	11	4,80	800
48160.16	160	GL	220	80 x 107	11	6,80	1000
48200.16	200	GL	260	80 x 107	11	8,50	1200

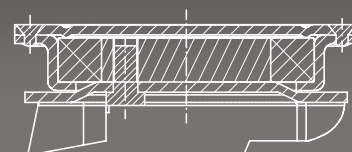



Kolečka samostatná pro vysoké teploty serie 47000

typ	mm	mm		mm	mm	kg	kg
47100.02	100	32	KL	12	40	0,38	100
47140.01	140	40	JL	20	60	1,12	250
47180.01	180	45	JL	20	60	1,55	250

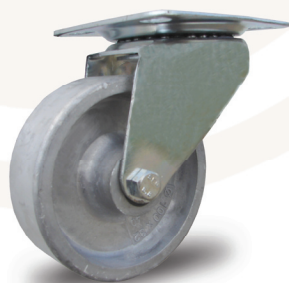

Kolečka otočná s přírubou pro vysoké teploty serie 47000

typ	mm		mm	mm	mm	kg	kg
47100.05	100	KL	123	85	60 x 80	0,87	100
47140.04	140	JL	175	120	80 x 107	2,29	200
47180.04	180	JL	222	143	80 x 107	2,08	200



Kolečka pevná pro vysoké teploty serie 47000

typ	mm		mm	mm	kg	kg
47100.15	100	KL	123	60 x 80	0,65	100
47140.14	140	JL	175	80 x 107	2,07	200
47180.14	180	JL	222	80 x 107	2,47	200



Kolečka otočná s otvorem pro vysoké teploty serie 47000

typ	mm		mm	mm	mm	kg	kg
47100.21	100	KL	121	91	12,5	0,81	100
47140.23	140	JL	165	116	16	1,92	180
47180.23	180	JL	217	142	16	2,63	180

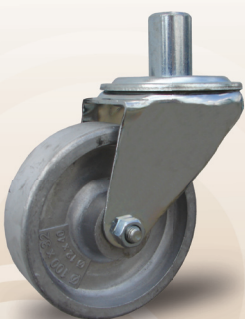

Kolečka otočná s čepem pro vysoké teploty serie 47000

typ	mm		mm	mm	mm	kg	kg
47100.44	100	KL	123	85	25	0,86	100
47140.10	140	JL	175	120	25	2,68	180
47180.10	180	JL	222	143	25	3,12	180

> PA pro vysoké teploty 250°C



Kolečka samostatná pro vysoké teploty serie 46000

typ	mm	mm		mm	mm	kg	kg
46080.02	80	30	KI	12	40	0,14	100
46100.02	100	30	KL	12	40	0,17	100
46160.02	160	40	KL	20	45	0,55	100



Kolečka otočná s přírubou pro vysoké teploty serie 46000

typ	mm		mm	mm	mm	kg	kg
46080.05	80	KL	104	82	60 x 80	0,69	100
46100.05	100	KL	123	85	60 x 80	0,73	100
46160.05	160	KL	190	133	80 x 70	1,75	100



Kolečka pevná pro vysoké teploty serie 46000

typ	mm		mm	mm	kg	kg
46080.15	80	KL	104	60 x 80	0,46	100
46100.15	100	KL	123	60 x 80	0,50	100
46160.15	160	KL	190	80 x 107	1,20	100



Kolečka otočná s otvorem pro vysoké teploty serie 46000

typ	mm		mm	mm	mm	kg	kg
46080.21	80	KL	100	82	12,5	0,52	100
46100.21	100	KL	121	91	12,5	0,60	100



Kolečka otočná s čepem pro vysoké teploty serie 46000

typ	mm		mm	mm	mm	kg	kg
46080.44	80	KL	101	82	24	0,76	100
46100.44	100	KL	123	85	24	0,80	100

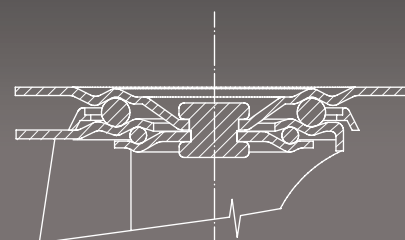

> kolečka

> kolečka otočná transportní > 350 - 600 kg > serie 33000

> odpružená, polyuretanová obruč, litinový střed

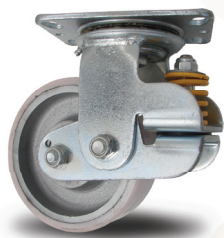

Kolečka odpružená otočná serie 33000

typ	mm		mm	mm	kg	kg
33150.06	150	GL	200	130 x 70	6,29	350 / 600

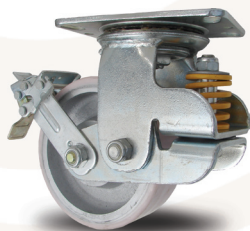

Kolečka odpružená otočná s brzdou serie 33000

typ	mm		mm	mm	kg	kg
33150.09	150	GL	200	130 x 70	6,65	350 / 600

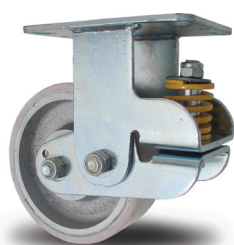

Kolečka odpružená pevná serie 33000

typ	mm		mm	mm	kg	kg
33150.16	150	GL	200	130 x 70	5,6	350 / 600

> kolečka otočná transportní > 100 - 180 kg > serie 50000

> polyamidová, nerezová konzola



INOX

Kolečka otočná s nerezovou přírubou serie 50000

typ	mm		mm	mm	mm	kg	kg
50080.04	80	JL	104	82	60 x 80	0,68	100
50100.04	100	JL	123	91	60 x 80	0,73	100
50125.04	125	JL	155	98	60 x 80	0,96	100
50160.04	160	JL	190	133	80 x 107	1,85	160
50200.04	200	JL	235	154	80 x 107	2,05	180
50080.05	80	KL	104	82	60 x 80	0,68	100
50100.05	100	KL	123	91	60 x 80	0,73	100
50125.05	125	KL	155	98	60 x 80	0,96	100
50160.05	160	KL	190	133	80 x 107	1,85	160
50200.05	200	KL	235	154	80 x 107	2,05	180



INOX

Kolečka pevná s nerezovou konzolou serie 50000

typ	mm		mm	mm	kg	kg
50080.14	80	JL	104	60 x 80	0,44	100
50100.14	100	JL	123	60 x 80	0,55	100
50125.14	125	JL	155	60 x 80	0,75	100
50160.14	160	JL	190	80 x 107	1,30	160
50200.14	200	JL	235	80 x 107	1,80	180
50080.15	80	KL	104	60 x 80	0,44	100
50100.15	100	KL	123	60 x 80	0,55	100
50125.15	125	KL	155	60 x 80	0,75	100
50160.15	160	KL	190	80 x 107	1,30	160
50200.15	200	KL	235	80 x 107	1,80	180

> pryžová obruč, kovový disk, kovová konzola



Kolečko otočné transportní serie 20000

typ	mm	Typ kola	mm		mm	mm	mm	mm	mm	kg	kg
20250.02	250	1003.12	80	JL	310	70	140 x 110	105 x 80	13	6,70	180



Kolečko otočné transportní serie 20000

typ	mm	Typ kola	mm		mm	mm	mm	mm	mm	kg	kg
20250.11	250	1005.14	80	JL	310	70	150 x 120	105 x 80	13	4,90	180



Kolečko otočné transportní serie 20000

typ	mm	Typ kola	mm		mm	mm	mm	mm	mm	kg	kg
20250.12	250	1003.12	80	JL	310	70	140 x 110	105 x 80	13	5,7	150



Kolečko otočné transportní serie 20000

typ	mm	Typ kola	mm		mm	mm	mm	mm	mm	kg	kg
20250.01	250	1005.14	80	JL	310	70	150 x 120	105 x 80	13	5,90	150

Legenda:

KL - kluzné uložení
 JL - jehlové ložisko
 GL - kuličkové ložisko

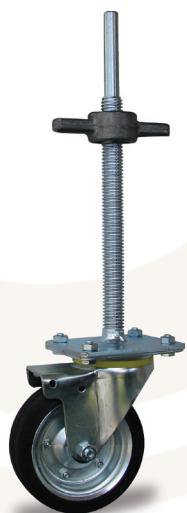

Kolečka otočná pro lešení s výškovou regulací - serie 11500

typ	mm		mm	mm	kg	kg
11501.01	160	JL	590	26	4,92	220
11501.02	160	JL	690	26	5,62	220
11501.03	160	JL	690	32	6,72	220
11502.01	200	JL	638	26	6,00	250
11502.02	200	JL	738	26	6,70	250
11502.03	200	JL	738	32	7,80	250

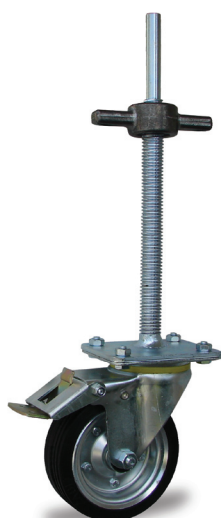

Kolečka otočná pro lešení s výškovou regulací s brzdou - serie 11500

typ	mm		mm	mm	kg	kg
11501.04	160	JL	590	26	5,30	220
11501.05	160	JL	690	26	6,00	220
11501.06	160	JL	690	32	7,10	220
11502.04	200	JL	638	26	6,20	250
11502.05	200	JL	738	26	6,90	250
11502.06	200	JL	738	32	8,00	250

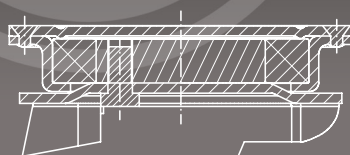



**vozíky ploštinové
a vozíky policové**



Plošinový vozík s jedním madlem se svislými příčkami serie 52000

1	Nosnost (kg)	2	Nosnost (kg)	3	Nosnost (kg)	4	Nosnost (kg)	5	Nosnost (kg)	d x š x v (mm)	Ložná plocha (mm)	Výška plošiny (mm)
52608.01	500	52608.03	600	52608.07	400	52608.05	300	52608.09	500	1015 x 610 x 970	800 x 600	240
52610.01	500	52610.03	600	52610.07	400	52610.05	300	52610.09	500	1115 x 610 x 970	1000 x 600	240
52611.01	500	52611.03	600	52611.07	400	52611.05	300	52611.09	500	1215 x 610 x 970	1100 x 600	240
52612.01	500	52612.03	600	52612.07	400	52612.05	300	52612.09	500	1315 x 610 x 970	1200 x 600	240
52711.01	500	52711.03	600	52711.07	400	52711.05	500	52711.09	500	1215 x 710 x 970	1100 x 700	240
52712.01	500	52712.03	600	52712.07	400	52712.05	500	52712.09	500	1315 x 710 x 970	1200 x 700	240
52811.01	500	52811.03	600	52811.07	400	52811.05	500	52811.09	500	1215 x 810 x 970	1100 x 800	240
52812.01	500	52812.03	600	52812.07	400	52812.05	500	52812.09	500	1315 x 810 x 970	1200 x 800	240
52813.01	500	58813.03	600	52813.07	400	58813.05	500	52813.09	500	1415 x 810 x 970	1300 x 800	240

Plošinový vozík se dvěma madly se svislými příčkami serie 52000



1	Nosnost (kg)	2	Nosnost (kg)	3	Nosnost (kg)	4	Nosnost (kg)	5	Nosnost (kg)	d x š x v (mm)	Ložná plocha (mm)	Výška plošiny (mm)
52608.02	500	52608.04	600	52608.08	400	52608.06	300	52608.10	500	1125 x 610 x 970	800 x 600	240
52610.02	500	52610.04	600	52610.08	400	52610.06	300	52610.10	500	1225 x 610 x 970	1000 x 600	240
52611.02	500	52611.04	600	52611.08	400	52611.06	300	52611.10	500	1325 x 610 x 970	1100 x 600	240
52612.02	500	52612.04	600	52612.08	400	52612.06	300	52612.10	500	1425 x 610 x 970	1200 x 600	240
52711.02	500	52711.04	600	52711.08	400	52711.06	500	52711.10	500	1325 x 710 x 970	1100 x 700	240
52712.02	500	52712.04	600	52712.08	400	52712.06	500	52712.10	500	1425 x 710 x 970	1200 x 700	240
52811.02	500	52811.04	600	52811.08	400	52811.06	500	52811.10	500	1325 x 810 x 970	1100 x 800	240
52812.02	500	52812.04	600	52812.08	400	52812.06	500	52812.10	500	1425 x 810 x 970	1200 x 800	240
52813.02	500	52813.04	600	52813.08	400	52813.06	500	52813.10	500	1525 x 810 x 970	1300 x 800	240



Plošinový vozík se dvěma madly, dvěma bočnicemi se svislými příčkami serie 52000

1	Nosnost (kg)	2	Nosnost (kg)	3	Nosnost (kg)	4	Nosnost (kg)	5	Nosnost (kg)	d x š x v (mm)	Ložná plocha (mm)	Výška plošiny (mm)
52711.41	500	52711.44	600	52711.43	400	52711.42	500	52711.45	500	1325 x 710 x 970	1100 x 700	240
52712.41	500	52712.44	600	52712.43	400	52712.42	500	52712.45	500	1425 x 710 x 970	1200 x 700	240
52811.41	500	52811.44	600	52811.43	400	52811.42	500	52811.45	500	1325 x 810 x 970	1100 x 800	240
52812.41	500	52812.44	600	52812.43	400	52812.42	500	52812.45	500	1425 x 810 x 970	1200 x 800	240
52813.41	500	52813.44	600	52813.43	400	52813.42	500	52813.45	500	1525 x 810 x 970	1300 x 800	240

* celková výška je uvedena pro vozíky s koly prům. 160 mm (vozíky s koly prům.210 mm V = 1030 mm, s koly prům. 260 mm V = 1080 mm)

** výška plošiny je uvedená pro vozíky s koly prům. 160 mm (vozíky s kol prům. 210 mm výška plošiny = 290 mm, s koly prům. 260 mm výška plošiny = 350mm)

u vozíků šíře 600 mm s nafukovacími koly jsou použita kola prům. 210 mm (viz. serie 16000 - 16210.11)





Plošinový vozík s jedním madlem s vodorovnými příčkami serie 52000

1	Nosnost (kg)	2	Nosnost (kg)	3	Nosnost (kg)	4	Nosnost (kg)	5	Nosnost (kg)	d x š x v (mm)	* Ložná plocha (mm)	** Výška plošiny (mm)
52608.11	500	52608.13	600	52608.17	400	52608.15	300	52608.19	500	1015 x 610 x 970	800 x 600	240
52610.11	500	52610.13	600	52610.17	400	52610.15	300	52610.19	500	1115 x 610 x 970	1000 x 600	240
52611.11	500	52611.13	600	52611.17	400	52611.15	300	52611.19	500	1215 x 610 x 970	1100 x 600	240
52612.11	500	52612.13	600	52612.17	400	52612.15	300	52612.19	500	1315 x 610 x 970	1200 x 600	240
52711.11	500	52711.13	600	52711.17	400	52711.15	500	52711.19	500	1215 x 710 x 970	1100 x 700	240
52712.11	500	52712.13	600	52712.17	400	52712.15	500	52712.19	500	1315 x 710 x 970	1200 x 700	240
52811.11	500	52811.13	600	52811.17	400	52811.15	500	52811.19	500	1215 x 810 x 970	1100 x 800	240
52812.11	500	52812.13	600	52812.17	400	52812.15	500	52812.19	500	1315 x 810 x 970	1200 x 800	240
52813.11	500	52813.13	600	52813.17	400	52813.15	500	52813.19	500	1415 x 810 x 970	1300 x 800	240



Plošinový vozík se dvěma madly s vodorovnými příčkami serie 52000

1	Nosnost (kg)	2	Nosnost (kg)	3	Nosnost (kg)	4	Nosnost (kg)	5	Nosnost (kg)	d x š x v (mm)	* Ložná plocha (mm)	** Výška plošiny (mm)
52608.12	500	52608.14	600	52608.18	400	52608.16	300	52608.20	500	1125 x 610 x 970	800 x 600	240
52610.12	500	52610.14	600	52610.18	400	52610.16	300	52610.20	500	1225 x 610 x 970	1000 x 600	240
52611.12	500	52611.14	600	52611.18	400	52611.16	300	52611.20	500	1325 x 610 x 970	1100 x 600	240
52612.12	500	52612.14	600	52612.18	400	52612.16	300	52612.20	500	1425 x 610 x 970	1200 x 600	240
52711.12	500	52711.14	600	52711.18	400	52711.16	500	52711.20	500	1325 x 710 x 970	1100 x 700	240
52712.12	500	52712.14	600	52712.18	400	52712.16	500	52712.20	500	1425 x 710 x 970	1200 x 700	240
52811.12	500	52811.14	600	52811.18	400	52811.16	500	52811.20	500	1325 x 810 x 970	1100 x 800	240
52812.12	500	52812.14	600	52812.18	400	52812.16	500	52812.20	500	1425 x 810 x 970	1200 x 800	240
52813.12	500	52813.14	600	52813.18	400	52813.16	500	52813.20	500	1525 x 810 x 970	1300 x 800	240

* celková výška je uvedena pro vozíky s koly prům. 160 mm (vozíky s koly prům.210 mm V = 1030 mm, s koly prům. 260 mm V = 1080 mm)

** výška plošiny je uvedená pro vozíky s koly prům. 160 mm (vozíky s kol prům. 210 mm výška plošiny = 290 mm, s koly prům. 260 mm výška plošiny = 350mm)
u vozíků šíře 600 mm s nafukovacími koly jsou použita kola prům. 210 mm (viz. serie 16000 - 16210.11)

Vozíky serie 52000 jsou opatřeny vodovzdornou protiskluzovou deskou.

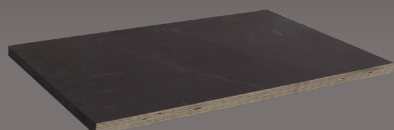

Vozíky lze dodat i s nízkými bočnicemi.





Plošinový vozík s jedním madlem se sítí serie 52000

1	Nosnost (kg)	2	Nosnost (kg)	3	Nosnost (kg)	4	Nosnost (kg)	5	Nosnost (kg)	d x š x v (mm)	Ložná plocha (mm)	Výška plošiny (mm)
52608.21	500	52608.23	600	52608.27	400	52608.25	300	52608.29	500	1015 x 610 x 970	800 x 600	240
52610.21	500	52610.23	600	52610.27	400	52610.25	300	52610.29	500	1115 x 610 x 970	1000 x 600	240
52611.21	500	52611.23	600	52611.27	400	52611.25	300	52611.29	500	1215 x 610 x 970	1100 x 600	240
52612.21	500	52612.23	600	52612.27	400	52612.25	300	52612.29	500	1315 x 610 x 970	1200 x 600	240
52711.21	500	52711.23	600	52711.27	400	52711.25	500	52711.29	500	1215 x 710 x 970	1100 x 700	240
52712.21	500	52712.23	600	52712.27	400	52712.25	500	52712.29	500	1315 x 710 x 970	1200 x 700	240
52811.21	500	52811.23	600	52811.27	400	52811.25	500	52811.29	500	1215 x 810 x 970	1100 x 800	240
52812.21	500	52812.23	600	52812.27	400	52812.25	500	52812.29	500	1315 x 810 x 970	1200 x 800	240
52813.21	500	52813.23	600	52813.27	400	52813.25	500	52813.29	500	1415 x 810 x 970	1300 x 800	240



Plošinový vozík s dvěma madly se sítí serie 52000

1	Nosnost (kg)	2	Nosnost (kg)	3	Nosnost (kg)	4	Nosnost (kg)	5	Nosnost (kg)	d x š x v (mm)	Ložná plocha (mm)	Výška plošiny (mm)
52608.22	500	52608.24	600	52608.28	400	52608.26	300	52608.30	500	1125 x 610 x 970	800 x 600	240
52610.22	500	52610.24	600	52610.28	400	52610.26	300	52610.30	500	1225 x 610 x 970	1000 x 600	240
52611.22	500	52611.24	600	52611.28	400	52611.26	300	52611.30	500	1325 x 610 x 970	1100 x 600	240
52612.22	500	52612.24	600	52612.28	400	52612.26	300	52612.30	500	1425 x 610 x 970	1200 x 600	240
52711.22	500	52711.24	600	52711.28	400	52711.26	500	52711.30	500	1325 x 710 x 970	1100 x 700	240
52712.22	500	52712.24	600	52712.28	400	52712.26	500	52712.30	500	1425 x 710 x 970	1200 x 700	240
52811.22	500	52811.24	600	52811.28	400	52811.26	500	52811.30	500	1325 x 810 x 970	1100 x 800	240
52812.22	500	52812.24	600	52812.28	400	52812.26	500	52812.30	500	1425 x 810 x 970	1200 x 800	240
52813.22	500	52813.24	600	52813.28	400	52813.26	500	52813.30	500	1525 x 810 x 970	1300 x 800	240



Plošinový vozík s dvěma madly, dvěma bočnicemi se sítí serie 52000

1	Nosnost (kg)	2	Nosnost (kg)	3	Nosnost (kg)	4	Nosnost (kg)	5	Nosnost (kg)	d x š x v (mm)	Ložná plocha (mm)	Výška plošiny (mm)
52711.61	500	52711.64	600	52711.63	400	52711.62	500	52711.65	500	1325 x 710 x 970	1100 x 700	240
52712.61	500	52712.64	600	52712.63	400	52712.62	500	52712.65	500	1425 x 710 x 970	1200 x 700	240
52811.61	500	52811.64	600	52811.63	400	52811.62	500	52811.65	500	1325 x 810 x 970	1100 x 800	240
52812.61	500	52812.64	600	52812.63	400	52812.62	500	52812.65	500	1425 x 810 x 970	1200 x 800	240
52813.61	500	52813.64	600	52813.63	400	52813.62	500	52813.65	500	1525 x 810 x 970	1300 x 800	240

* celková výška je uvedena pro vozíky s koly prům. 160 mm (vozíky s koly prům. 210 mm V = 1030 mm, s koly prům. 260 mm V = 1080 mm)

** výška plošiny je uvedena pro vozíky s koly prům. 160 mm (vozíky s kol prům. 210 mm výška plošiny = 290 mm, s koly prům. 260 mm výška plošiny = 350mm)

u vozíků širě 600 mm s nafukovacími koly jsou použita kola prům. 210 mm (viz. serie 16000 - 16210.11)





Plošinový vozík s jedním madlem s deskou serie 52000

1	Nosnost (kg)	2	Nosnost (kg)	3	Nosnost (kg)	4	Nosnost (kg)	5	Nosnost (kg)	d x š x v (mm)	Ložná plocha (mm)	Výška plošiny (mm)
52608.31	500	52608.33	600	52608.37	400	52608.35	300	52608.39	500	1015 x 610 x 970	800 x 600	240
52610.31	500	52610.33	600	52610.37	400	52610.35	300	52610.39	500	1115 x 610 x 970	1000 x 600	240
52611.31	500	52611.33	600	52611.37	400	52611.35	300	52611.39	500	1215 x 610 x 970	1100 x 600	240
52612.31	500	52612.33	600	52612.37	400	52612.35	300	52612.39	500	1315 x 610 x 970	1200 x 600	240
52711.31	500	52711.33	600	52711.37	400	52711.35	500	52711.39	500	1215 x 710 x 970	1100 x 700	240
52712.31	500	52712.33	600	52712.37	400	52712.35	500	52712.39	500	1315 x 710 x 970	1200 x 700	240
52811.31	500	52811.33	600	52811.37	400	52811.35	500	52811.39	500	1215 x 810 x 970	1100 x 800	240
52812.31	500	52812.33	600	52812.37	400	52812.35	500	52812.39	500	1315 x 810 x 970	1200 x 800	240
52813.31	500	52813.33	600	52813.37	400	52813.35	500	52813.39	500	1415 x 810 x 970	1300 x 800	240



Plošinový vozík s dvěma madly s deskou serie 52000

1	Nosnost (kg)	2	Nosnost (kg)	3	Nosnost (kg)	4	Nosnost (kg)	5	Nosnost (kg)	d x š x v (mm)	Ložná plocha (mm)	Výška plošiny (mm)
52608.32	500	52608.34	600	52608.38	400	52608.36	300	52608.40	500	1125 x 610 x 970	800 x 600	240
52610.32	500	52610.34	600	52610.38	400	52610.36	300	52610.40	500	1225 x 610 x 970	1000 x 600	240
52611.32	500	52611.34	600	52611.38	400	52611.36	300	52611.40	500	1325 x 610 x 970	1100 x 600	240
52612.32	500	52612.34	600	52612.38	400	52612.36	300	52612.40	500	1425 x 610 x 970	1200 x 600	240
52711.32	500	52711.34	600	52711.38	400	52711.36	500	52711.40	500	1325 x 710 x 970	1100 x 700	240
52712.32	500	52712.34	600	52712.38	400	52712.36	500	52712.40	500	1425 x 710 x 970	1200 x 700	240
52811.32	500	52811.34	600	52811.38	400	52811.36	500	52811.40	500	1325 x 810 x 970	1100 x 800	240
52812.32	500	52812.34	600	52812.38	400	52812.36	500	52812.40	500	1425 x 810 x 970	1200 x 800	240
52813.32	500	52813.34	600	52813.38	400	52813.36	500	52813.40	500	1525 x 810 x 970	1300 x 800	240



Plošinový vozík s dvěma madly, dvěma bočnicemi s deskou serie 52000

1	Nosnost (kg)	2	Nosnost (kg)	3	Nosnost (kg)	4	Nosnost (kg)	5	Nosnost (kg)	d x š x v (mm)	Ložná plocha (mm)	Výška plošiny (mm)
52711.71	500	52711.74	600	52711.73	400	52711.72	500	52711.75	500	1325 x 710 x 970	1100 x 700	240
52712.71	500	52712.74	600	52712.73	400	52712.72	500	52712.75	500	1425 x 710 x 970	1200 x 700	240
52811.71	500	52811.74	600	52811.73	400	52811.72	500	52811.75	500	1325 x 810 x 970	1100 x 800	240
52812.71	500	52812.74	600	52812.73	400	52812.72	500	52812.75	500	1425 x 810 x 970	1200 x 800	240
52813.71	500	52813.74	600	52813.73	400	52813.72	500	52813.75	500	1525 x 810 x 970	1300 x 800	240

* celková výška je uvedena pro vozíky s koly prům. 160 mm (vozíky s koly prům.210 mm V = 1030 mm, s koly prům. 260 mm V = 1080 mm)

** výška plošiny je uvedená pro vozíky s koly prům. 160 mm (vozíky s kol prům. 210 mm výška plošiny = 290 mm, s koly prům. 260 mm výška plošiny = 350mm)

u vozíků šíře 600 mm s nafukovacími koly jsou použita kola prům. 210 mm (viz. serie 16000 - 16210.11)

Vozíky serie 52000 jsou opatřeny
vodvzdornou protiskluzovou deskou.

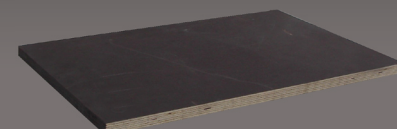



Vozíky plošinové - 1 madlo s vodorovnými příčkami serie 51000

Typ	Kolo Ø	Kolo ulož.	Kolo typ	d x š x v (mm)	Nosnost (kg)	Deska typ	Ložná plocha (mm)	Výška plošiny (mm)
51035.03	125	KL	40125.2100KL 40125.2200BKL	1010 x 600 x 940	150	vodovzdorná	800 x 600	190
51005.12	160	JL	41160.14PIL 41160.04OIL	1310 x 600 x 967	300	dřevotříška tl.18mm	1200 x 600	240



Vozíky plošinové - 2 madla s vodorovnými příčkami serie 51000

Typ	Kolo Ø	Kolo ulož.	Kolo typ	d x š x v (mm)	Nosnost (kg)	Deska typ	Ložná plocha (mm)	Výška plošiny (mm)
51035.02	125	KL	40125.2100KL 40125.2200BKL	1010 x 600 x 940	150	vodovzdorná	800 x 600	190



Vozíky plošinové - 2 madla se sítí serie 51000

Typ	Kolo Ø	Kolo ulož.	Kolo typ	d x š x v (mm)	Nosnost (kg)	Deska typ	Ložná plocha (mm)	Výška plošiny (mm)
51035.01	125	KL	40125.2100KL 40125.2200BKL	1010 x 600 x 940	150	vodovzdorná	800 x 600	190



Vozíky plošinové skládací serie 51000

Typ	Kolo Ø	Kolo ulož.	d x š x v (mm)	Nosnost (kg)	Deska typ	Ložná plocha (mm)	Výška plošiny (mm)
51023.01	100	KL	750 x 480 x 860	150	plechová	630 x 450	140
51023.02	100	KL	720 x 480 x 820	150	plechová	630 x 440	140
51024.02	125	KL	880 x 610 x 860	300	plechová	770 x 570	200



Vozíky plošinové - 1 madlo serie 51000

Typ	Kolo Ø	Kolo ulož.	Kolo typ	d x š x v (mm)	Nosnost (kg)	Deska typ	Ložná plocha (mm)	Výška plošiny (mm)
51017.01	100	KL	42100.2100KL	690 x 400 x 776	150	dřevotříška tl. 18mm	600 x 400	160
51037.01	100	KL	59100.2100KL	890 x 550 x 840	200	vodovzdorná	550 x 800	160



Vozíky plošinové pro 1 plastovou přepravku serie 51000

Typ	Kolo Ø	Kolo ulož.	Kolo typ	d x š x v (mm)	Nosnost (kg)	Ložná plocha (mm)	Výška plošiny (mm)
51006.10	100	KL	42100.2100KL	690 x 410 x 816	150	1 x plastová přepravka	120



Vozíky plošinové pro 2 plastové přepravky serie 51000

Typ	Kolo Ø	Kolo ulož.	Kolo typ	d x š x v (mm)	Nosnost (kg)	Ložná plocha (mm)	Výška plošiny (mm)
51021.01	200	JL	16200.07PIL 16200.080IL	900 x 610 x 940	150	2x plastová přepravka	265
51021.03	200	JL	41200.14PIL 41200.040IL	900 x 610 x 940	150	2x plastová přepravka	265



Vozíky plošinové pro 1 plastovou přepravku serie 51000

Typ	Kolo Ø	Kolo ulož.	Kolo typ	d x š x v (mm)	Nosnost (kg)	Ložná plocha (mm)	Výška plošiny (mm)
51007.05	75	KL	42075.2100KL	610 x 410	150	1x plastová přepravka	125



Vozíky plošinové - 2 madla serie 51000

Typ	Kolo Ø	Kolo ulož.	d x š x v (mm)	Nosnost (kg)	Deska typ	Ložná plocha (mm)	Výška plošiny (mm)
51018.01	100	KL	1130 x 500 x 890	250	překližka	1000 x 500	140



Vozíky plošinové - 2 madla serie 51000

Typ	Kolo Ø	Kolo ulož.	Kolo typ	d x š x v (mm)	Nosnost (kg)	Deska typ	Ložná plocha (mm)	Výška plošiny (mm)
51005.13	125	JL	41125.040IL 41125.14PIL	1520 x 1000 x 945	300	vodovzdorná tl. 21 mm	1300 x 1000	195



Vozíky plošinové - 2 bočnice se svislými příčkami serie 51000

Typ	Kolo Ø	Kolo ulož.	Kolo typ	d x š x v (mm)	Nosnost (kg)	Deska typ	Ložná plocha (mm)	Výška plošiny (mm)
51032.01	200	JL	41200.07OBIL 41200.04 OIL	1100 x 700 x 1680	250	vodovzdorná tl. 21 mm	1100 x 700	280

Vozíky plošinové s podjížděcí rukojetí serie 51000

Typ	Kolo Ø	Kolo ulož.	Kolo typ	d x š x v (mm)	Nosnost (kg)	Deska typ	Ložná plocha (mm)	Výška plošiny (mm)
51001.07	200	JL	41200.14 PIL 41200.01SIL	900 x 710 x 280	500	vodovzdorná tl. 21 mm	900 x 710	290



Vozíky zahradní serie 51000

Typ	Kolo Ø	Kolo ulož.	Kolo typ	d x š x v (mm)	Nosnost (kg)	Ložná plocha (mm)	Výška plošiny (mm)
51015.01	200(2x) 100(1x)	KL	2008.08 42100.11	670 x 570 x 860	140	390 x 540, 390 x 290	140/ 640



Vozíky plošinové na deskový materiál serie 51000

Typ	Kolo Ø	Kolo ulož.	Kolo typ	d x š x v (mm)	Nosnost (kg)	Ložná plocha (mm)	Výška plošiny (mm)
51019.01	200	JL	2 x 200 OBIL 2 x 200 PIL	1100 x 700 x 1450	750	1100 x 335	-

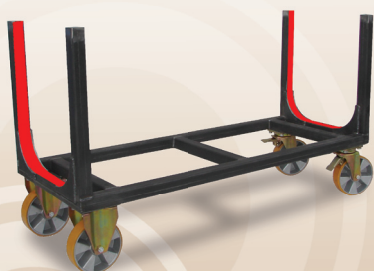

Vozíky plošinové pro přepravu tyčového materiálu - nosnost 2400kg serie 51000

Typ	Kolo Ø	Kolo ulož.	Kolo typ	d x š x v (mm)	Nosnost (kg)	Ložná plocha (mm)	Výška plošiny (mm)
51022.01	200	GL	35200.97 PGL 35200.94 OBGL	1500 x 500 x 850	2 400	1500 x 450	300





Vozíky plošinové - 2 madla se svislou příčkou serie 51000

Typ	Kolo Ø	Kolo ulož.	Kolo typ	d x š x v (mm)	Nosnost (kg)	Deska typ	Ložná plocha (mm)	Výška plošiny (mm)
51038.01	125 200	KL	40125.2100KL 2008.08	1800 x 420 x 1160	300	vodovzdorná	1500 x 380	240



Vozíky plošinové bez madla serie 51000

Typ	Kolo Ø	Kolo ulož.	Kolo typ	d x š x v (mm)	Nosnost (kg)	Deska typ	Ložná plocha (mm)	Výška plošiny (mm)
51025.01	200	JL	41200.040IL 41200.14PIL	920 x 520 x 260	250	vodovzdorná tl. 21 mm	920 x 520	260



Vozíky plošinové bez madla serie 51000

Typ	Kolo Ø	Kolo ulož.	Kolo typ	d x š x v (mm)	Nosnost (kg)	Deska typ	Ložná plocha (mm)	Výška plošiny (mm)
51025.11	100	JL	42100.04 00KL	600 x 400 x 160	100	vodovzdorná tl. 21 mm	600 x 400	160



Oje k vozíkům - podjížděcí rukojeti serie 51000

Typ	Kolo Ø	Kolo typ	Nosnost (kg)
51102.01	160	31160.01	200
51103.01	200	31200.01	300

Vodovzdorná plocha tl. 18 mm
s protiskluzovým povrchem.

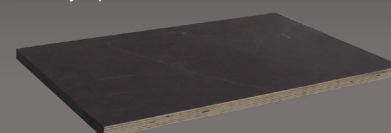



Vozíky policové - 2 PDV 650 x 410/990 x 590mm nosnost 2 x 70/2 x 100kg serie 60000

Typ	Kolo Ø	Kolo ulož.	Kolo typ	d x š x v (mm)	Nosnost (kg)	Deska typ	Ložná plocha (mm)	Výška plošiny (mm)
60002.01	80	KL	40080.2100KL	880 x 450 x 940	2 x 70	vodovzdorná tl. 12 mm	650 x 410	215/745
60002.02	80	KL	40080.2100KL	1220 x 630 x 1240	2 x 100	vodovzdorná tl. 15 mm	990 x 590	290/1030



Vozíky policové - 2 PDD 825 x 570mm nosnost 2 x 100kg serie 60000

Typ	Kolo Ø	Kolo ulož.	Kolo typ	d x š x v (mm)	Nosnost (kg)	Deska typ	Ložná plocha (mm)	Výška plošiny (mm)
60002.03	125	KL	42125.2100KL	850 x 570 x 852	2 x 100	dřevotřísková tl. 17 mm	825 x 570	260/710



Vozíky policové - 2 PDV790 x 550/910 x 500mm nosnost 2 x 70/2x50kg PROFIL serie 60000

Typ	Kolo Ø	Kolo ulož.	Kolo typ	d x š x v (mm)	Nosnost (kg)	Deska typ	Ložná plocha (mm)	Výška plošiny (mm)
60002.04	100	KL	40100.2200BKL 40100.79POKL	920 x 580 x 1100	2 x 70	vodovzdorná tl. 21 mm	790 x 550	250/990
60002.32	80	KL	40080.2100KL 40080.220BKL	920 x 510 x 920	2 x 50	vodovzdorná tl. 15 mm	910 x 500	520/830



Vozíky policové - 3 PDV 950 x 550 nosnost 3 x 100kg serie 60000

Typ	Kolo Ø	Kolo ulož.	Kolo typ	d x š x v (mm)	Nosnost (kg)	Deska typ	Ložná plocha (mm)	Výška plošiny (mm)
60003.01	100	KL	40100.2100KL	1180 x 590 x 1260	3 x 100	vodovzdorná tl. 15 mm	950 x 550	290/646 /1002



Vozíky policové - 3 PDD/PDV 940 x 415/650 x 410mm nosnost 3 x 60/3 x 70kg serie 60000

Typ	Kolo Ø	Kolo ulož.	Kolo typ	d x š x v (mm)	Nosnost (kg)	Deska typ	Ložná plocha (mm)	Výška plošiny (mm)
60003.02	75	KL	42075.21 00KL	1000 x 420 x 770	3 x 60	dřevotřísková tl. 12 mm	940 x 415	140/405 /670
60003.03	80	KL	40080.21 00KL 40080.22 00BKL	700 x 410 x 770	3 x 70	vodovzdorná tl. 12 mm	650 x 410	150/420 /680



Vozíky policové - 2 PDV1060 x 790mm nosnost 2 x 200kg PROFI serie 60000

Typ	Kolo Ø	Kolo ulož.	Kolo typ	d x š x v (mm)	Nosnost (kg)	Deska typ	Ložná plocha (mm)	Výška plošiny (mm)
60002.21	200	JL	41200.14PIL 41200.04OIL	1180 x 790 x 900	2 x 200	vodovzdorná tl. 21 mm	1060 x 790	285/785



Vozíky policové - 2 PDP 910 x 500mm nosnost 2 x 50kg serie 60000

Typ	Kolo Ø	Kolo ulož.	Kolo typ	d x š x v (mm)	Nosnost (kg)	Deska typ	Ložná plocha (mm)	Výška plošiny (mm)
60002.31	80	KL	2 x OBKL 2 x OKL	920 x 510 x 920	2 x 50	plechová	910 x 500	520/830

Legenda:

3 PDV - tři police s deskami dřevěnými vodovzdornými

2 PDD - dvě police s deskami dřevotřískovými

2 PDP - dvě police s deskami plechovými





Vozík plošinový hliníkový skladací 53001.01

Typ	Kolo Ø	d x š x v (mm)	Nosnost (kg)	Ložná plocha (mm)	Výška plošiny (mm)
53001.01	100	700 x 420 x 950	150	620 x 420	160

Rudl skládací hliníkový 26 201.01 - lopata 355 x 230mm, nosnost 90kg

Rudl typ	Kolo Ø	Provedení kol	Rozměr rozložený (mm)	Rozměr složený (mm)	Ložná plocha š x h (mm)	Hmotnost (kg)	Nosnost (kg)
26201.01	150	pryž. obruč, kov. disk	1 100 x 400	720 x 400 x 200	355 x 230	7	90



Rudl hliníkový 26 002.01 - lopata 280x260mm, nosnost 120kg

Rudl typ	Kolo Ø	Kolo typ	Provedení kol	Výška x šířka (mm)	Ložná plocha š x h (mm)	Hmotnost (kg)	Nosnost (kg)
26002.01	260	4001.01	plast.disk, KL bantam s duší	1 250 x 460	280 x 260	6	120





**zdvížné vozíky
paletovací,
vysokozdvížné,
zvedací stoly**



Nízkozdvižné paletové vozíky

Typ	Délka vidlice (mm)	Kola	Nosnost (kg)
27075.13	1150	Al-Pu/Pu	2500
27075.21	1500	Al-Pu/Pu	2000
27075.22	1800	Al-Pu/Pu	2000
27075.20	2000	Al-Pu/Pu	2000



Nízkozdvižné paletové vozíky PROFI

Typ	Délka vidlice (mm)	Kola	Nosnost (kg)
27075.04	800 PROFI	Al-Pu/Pu	2500
27075.05	950 PROFI	Al-Pu/Pu	2500
27075.03	1150 PROFI	Al-Pu/Pu	2500



Nízkozdvižné paletové vozíky PROFI

Typ	Délka vidlice (mm)	Kola	Nosnost (kg)
27075.08	2500	Al-Pu/Pu	3500

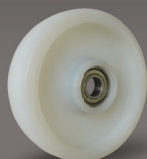
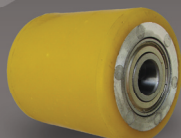
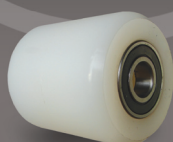

> s váhou



Nízkozdvížené paletové vozíky s váhou
27601.04

Celková šířka (mm)	550
Šířka lyžiny (mm)	185
Zdvih (mm)	125
Délka lyžin (mm)	1150
Výška celkem (mm)	1120
Délka celkem (mm)	1620
Hmotnost (kg)	80
Nosnost (kg)	2000
Rozměr kola - přední	200AI/G
Rozměr kola - zadní	80x70 Pa
Zákl. parametry váhy	Typ PV 102
Horní mez váživosti	2000 kg
Dolní mez váživosti	10 kg
Hodnota dílku přesnosti	e=d= 0,5/1 kg
Třída přesnosti	III. třída přesnosti (0,05%)
Rozsah tarování	T = -Max
Rozsah prac. teplot	-5 až +40 °C



Nízkozdvížené paletové vozíky s váhou
a tiskárnou 27601.02

Celková šířka (mm)	555
Šířka lyžiny (mm)	160
Zdvih (mm)	115
Délka lyžin (mm)	1150
Výška celkem (mm)	1200
Délka celkem (mm)	1535
Hmotnost (kg)	136
Nosnost (kg)	2000
Rozměr kola - přední	180AI-Pu
Rozměr kola - zadní	82x70 Pu
Horní mez váživosti	2000 kg
Odchylka vážení	+ - 1 kg
Napájení	4 ks alkalických baterií AA



Nízkozdvížené paletové vozíky - NV 2000 - RYCHLOZDVIH L 1150mm
27075.09

Celková šířka (mm)	550	Výška celkem (mm)	1220
Šířka lyžiny (mm)	160	Délka celkem (mm)	1600
Délka lyžiny (mm)	1150	Nosnost (kg)	2000
Zdvih (mm)	115	Hmotnost (kg)	80
Úhel natáčení	204°	Rozměr kola - přední	200 AI - Pu
Výška lyžin MIN (mm)	85	Rozměr kola - zadní	80 x 70 Pu
Výška lyžin MAX (mm)	200		

Legenda:

Pa - kolo polyamidové

Pu - kolo polyuretanové

DL - G - kolo pryžové, hliníkový střed

Vysokozdvížné vozíky s ručním zdvihem

	Typ	Nosnost (kg)	Max. zdvih (mm)	Délka vidlic (mm)
A	22004.05	1000	1550	1150
B	22004.02	1500	1600	1100
C	22004.03	1000	2500	1150

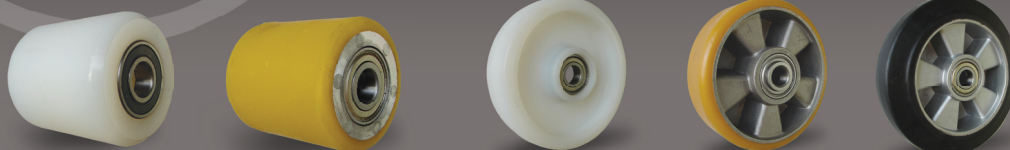



Paletové nůžkové vozíky

Typ	Nosnost (kg)	Kola	Max. výška zdvihu (mm)	Min. výška vidlice (mm)	Délka vidlice (mm)	Šířka přes vidlice (mm)
27501.05	1000	Pu/Pu	800	90	1150	520

Legenda:

Pa - kolo polyamidové

Pu - kolo polyuretanové

DL - G - kolo pryžové, hliníkový střed



Zdvižné stoly nůžkové

Typ	Nosnost (kg)	Zdvih (mm)	Min. výška (mm)	Rozměr stolu (mm)
29001.01	300	900	340	855 x 500
29001.02	500	900	340	855 x 500



Zdvižné stoly nůžkové

Typ	Nosnost (kg)	Zdvih (mm)	Min. výška (mm)	Rozměr stolu (mm)
29002.01	300	730	260	820 x 520



Zdvižné stoly nůžkové

Typ	Nosnost (kg)	Zdvih (mm)	Min. výška (mm)	Rozměr stolu (mm)
29004.02	350	1620	440	1100 x 520



Zdvižné stoly 29003.01

Typ	Nosnost (kg)	Zdvih (mm)	Min. výška (mm)	Rozměr stolu (mm)	Kolo (mm)
29003.01	400	1500	200	650 x 550	150

Zdvižné paletové vozíky (rudle) na krby - serie 27070.00

Celková šířka (mm)	656	Výška celkem (mm)	1091
Šířka lyžiny (mm)	100	Délka celkem (mm)	817
Délka lyžiny (mm)	625	Nosnost (kg)	250
Zdvih (mm)	760	Hmotnost (kg)	53
Úhel natáčení	-	Rozměr kola - přední	50 OKL
Výška lyžin MIN (mm)	70	Rozměr kola - zadní	160
Výška lyžin MAX (mm)	760		



Nízkozdvižný vozík Standart 27075.13

Nosnost 2500 kg
Lyžiny = 1150 mm





ostatní výrobky



Rukojeť plastová s ochranou 24,8-27,8 mm 9005 + 9009.00

Rukojeť typ	Barva	Pro trubku Ø (mm)	Délka (mm)
9005.00	šedá	24,8	175
9005.01	šedá	25,2	175
9005.02	šedá	25,3	175
9009.00	šedá	27,8	175



Rukojeť plastová 25 mm 9004.00

Rukojeť typ	Barva	Pro trubku Ø (mm)	Délka (mm)
9004.00	černá	25	105



Rukojeť plastová 25mm 9004.01

Rukojeť typ	Barva	Pro trubku Ø (mm)	Délka (mm)
9004.01	černá	25	105



Rukojeť plastová 25mm 9004.02

Rukojeť typ	Barva	Pro trubku Ø (mm)	Délka (mm)
9004.02	černá	25	105



> plastové, pryžové



Rukojeť pryžová 32 mm 9001.01

Rukojeť typ	Barva	Pro trubku Ø (mm)	Délka (mm)
9001.01	černá	32	120



Rukojeť plastová 32 mm 9010.00

Rukojeť typ	Barva	Pro trubku Ø (mm)	Délka (mm)
9010.00	zelená	32	105



Rukojeť plastová 22 mm 9006.00

Rukojeť typ	Barva	Pro trubku Ø (mm)	Délka (mm)
9006.00	černá	22	115



Rukojeť plastová 18 mm 9012

Rukojeť typ	Barva	Pro trubku Ø (mm)	Délka (mm)
9012.00	černá	18	80
9012.01	bílá	18	80





Krytky nábojů kol kovové

typ	mm	kg
10101.01	47 (vnější průměr ložiska)	0,04
10101.00	52 (vnější průměr ložiska)	0,04



Krytky nábojů kol plastové 10200.01

typ	mm	kg
10200.01	47 (vnější průměr ložiska)	0,04



Krytky nábojů kol plastové 10200.02

typ	mm	kg
10200.02	47 (vnější průměr ložiska)	0,04



Krytky nábojů kol plastové 10200,03

typ	mm	kg
10200.03	52 (vnější průměr ložiska)	0,05



Zajišťovací kloboučky serie 10000

typ	mm	mm	kg
10001.01	40	20	0,02

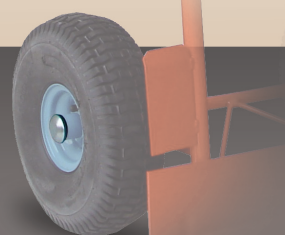



Nožní hustilka dvoupístová s manometrem 99067.01



Nožní hustilka jednopístová s manometrem 99067.02



Spirálové hadice 7,5 m s rychlospojkami 99068.01



Foukací pistole s manometrem a koncovkou 99066.01

Lze použít ke spirálové hadici obj. kód 99068.01.





Guma upínací 800 x 8mm 99100.01

Upínač typ	Rozměr (mm)	Ks v balení
99100.01	800 x 8	2



Guma upínací plochá 1000 x 150 x 4mm 99110,01

Upínač typ	Rozměr (mm)	Ks v balení
99110.01	1000 x 15 x 4	2



Guma upínací PAVOUK 800 x 8mm 99120,01

Upínač typ	Rozměr (mm)	Ks v balení
99120.01	800 x 8	1



Guma upínací PAVOUK 800 x 10mm 99120,02

Upínač typ	Rozměr (mm)	Ks v balení
99120.02	800 x 10	1



Pás upínací ráčnový jednodílný 5000 x 25mm 99150,01

Upínač typ	Rozměr (mm)	Ks v balení
99150.01	5000 x 25	1



Pás upínací ráčnový s háky dvoudílný 5000 x 28mm 99160.01

Upínač typ	Rozměr (mm)	Ks v balení
99160.01	5000 x 28	1





Zahradní plečka 91001.00

Typ	délka x šířka x výška (mm)	Šířka záběru (mm)	Hmotnost (kg)
91001.00	1200 x 550 x 970	150 - 300	8,4



Nahrnovací radlice 91502,00

Typ	délka x šířka x výška (mm)	Hmotnost (kg)
91502.00	280 x 230 x 260	0,8

Lze objednávat samostatně.



Radličky - nože k zahradní plečce 91505.00 + 91506.00

Typ	Nůž	Hmotnost (kg)
91505.00	levý	0,55
91506.00	pravý	0,55

Lze objednávat samostatně.

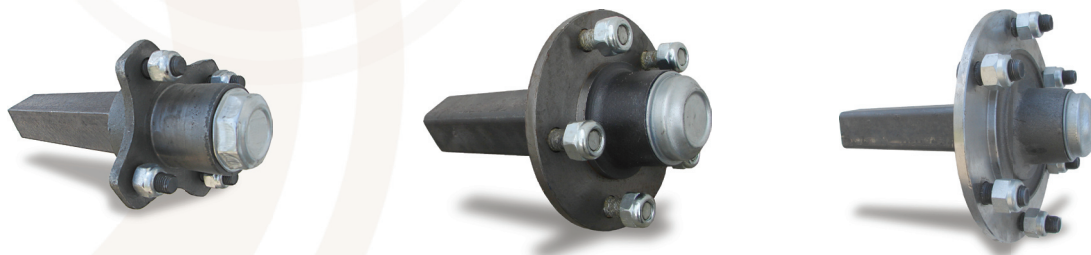

Kolečka díly - nábojové nápravy nebrzděné

Typ	Připojovací rozměry			Osa			
	Šrouby počet (ks)/rozměr	Průměr čepu A (mm)	Rozteč šroubů B (mm)	Průměr (mm)	Délka L (mm)	Hmotnost (mm)	Nosnost (mm)
89104.03	4/M12	58	98	40 x 40	200	4	750
89104.04	4/M12	62	95	40 x 40	200	4	750
89105.03	5/M16	93	140	45 x 45	200	9	1250
89105.04	5/M16	93	140	50 x 50	200	15	1650
89106.01	6/M18	160	205	50 x 50	200	12	1650
89106.03	6/M18	160	205	60 x 60	200	22	2350

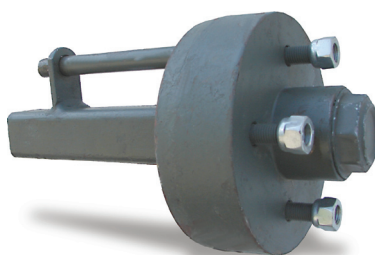

Kolečka díly - nábojové nápravy brzděné

Typ	Připojovací rozměry			Osa			
	Šrouby počet (ks)/rozměr	Průměr čepu A (mm)	Rozteč šroubů B (mm)	Průměr (mm)	Délka L (mm)	Hmotnost (mm)	Nosnost (mm)
89204.05	4/M12	58	98	40 x 40	200	7	750
89204.06	4/M12	62	95	40 x 40	200	7	750
89205.02	5/M16	93	140	45 x 45	200	11	1200
89205.03	5/M16	93	140	50 x 50	200	13	1650
89206.01	6/M18	160	205	50 x 50	200	16	1650
89206.02	6/M18	160	205	60 x 60	200	19	2350

Nábojová náprava nebrzděná

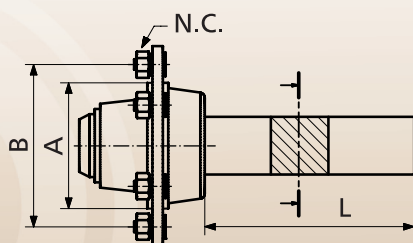

Nábojová náprava brzděná

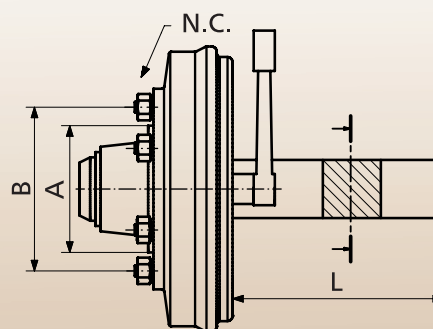



A Kladky polyamidové s radiusem s kluzným uložením

typ	mm		mm	mm	mm	mm	mm	kg	kg
87044.01	44	KL	12	29	12,5	28	30	0,01	60
87045.01	45	KL	6	16	3	34	16	0,01	60
87052.01	52	KL	10	15	5	45	16	0,01	60
87060.01	60	KL	10	15	4	48	16	0,01	60
87080.01	80	KL	10	16	5	68	17	0,01	60
87090.01	90	KL	12	28	5	70	28	0,21	80
87100.01	100	KL	12	28	5	70	28	0,26	80



B Kladky polyamidové s radiusem s kuličkovými ložisky

typ	mm		mm	mm	mm	mm	mm	kg	kg
87045.02	45	GL	10	16	5	33	16	0,02	60
87052.02	52	GL	15	15	5	45	16	0,03	60
87060.02	60	GL	15	15	5	47	16	0,03	60
87080.02	80	GL	12	28	8	70	28	0,30	80
87090.02	90	GL	15	15	5	45	16	0,25	60
87100.02	100	GL	12	28	8	70	28	0,30	80
87200.02	200	GL	20	45	20	160	45	0,70	300



C Kladky polyamidové s hranatým osazením s kuličkovými ložisky

typ	mm		mm	mm	mm	mm	kg	kg
87040.03	40	1xGL	12	14	8	34	0,01	60
87045.03	45	2xGL	10	30	25	36	0,02	60
87056.03	56	1xGL	15	14	6,8	48	0,01	60









> kladky polyamidové s kluzným uložením > serie 97000
> s náolkem

Kladky polyamidové s kluzným uložením - serie 97000

typ	mm		mm	mm	mm	kg	kg
97053.01	53	KL	8,2	24	33	0,0025	30
97079.01	79	KL	14,5	19	28	0,01	30



Válečky polyamidové s jedním kuličkovým ložiskem

 typ	 mm	 mm		 mm	 kg	 kg
83528.01	28	10	GL	8	0,008	60
83533.01	33	25	GL	8	0,028	60
83538.01	38	15	GL	8	0,03	60
83543.01	43	14	GL	12	0,02	60
83563.01	63	11	GL	17	0,097	60
83580.01	80	16	GL	15	0,17	60



Válečky polyamidové se dvěma kuličkovými ložisky

 typ	 mm	 mm		 mm	 mm	 kg	 kg
83045.01	45	19,5	GL	10	19,5	0,08	100
83048.01	48	21	GL	10	22	0,09	100
83050.01	50	21	GL	8	22	0,15	100
83055.01	55	32,5	GL	15	33	0,02	100
83055.98	55	32,5	GL	10	33	0,02	100

Kladky kovové typ V

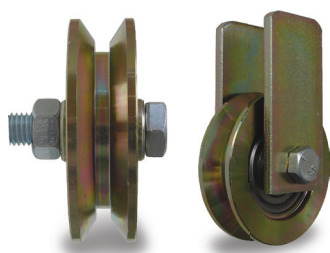

typ	mm	A	B	C	D	E	F	kg
KLADKY KOVOVÉ TYP V BEZ ÚCHYTU								
95079.01	79	79	22	28	12	13	5	200
95089.01	89	89	22	28	12	13	5	220
95117.01	117	117	22	28	12	10	8	220
KLADKY KOVOVÉ TYP V S ÚCHYTEM								
95079.02	79	79	22	28	12	13	5	200
95089.02	89	89	22	28	12	13	5	220
95117.02	117	117	22	28	12	10	8	220

Kladky kovové typ W

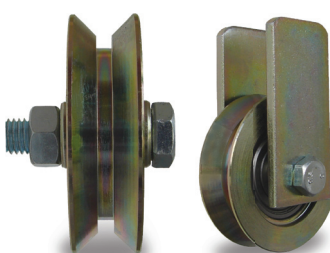

typ	mm	A	B	C	D	E	kg
KLADKY KOVOVÉ TYP W BEZ ÚCHYTU							
95079.11	79	79	22	28	12	9	200
95089.11	89	89	22	28	12	9	220
95117.11	117	117	22	28	12	10	220
KLADKY KOVOVÉ TYP W S ÚCHYTEM							
95079.12	79	79	22	28	12	9	200
95089.12	89	89	22	28	12	9	220
95117.12	117	117	22	28	12	10	220

Kladky kovové typ U

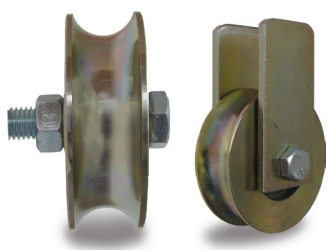

typ	mm	A	B	C	D	E	R	kg
KLADKY KOVOVÉ TYP U BEZ ÚCHYTU								
95079.21	79	79	26	28	12	9	11	200
95089.21	89	89	26	28	12	9	11	220
95089.23	89	89	32	42	12	10	14,5	220
95089.25	89	89	38	42	12	12	17	220
KLADKY KOVOVÉ TYP U S ÚCHYTEM								
95079.22	79	79	26	28	12	9	11	200
95089.22	89	89	26	28	12	9	11	220
95089.24	89	89	32	42	12	10	14,5	220
95089.26	89	89	38	42	12	12	17	220

Kladky kovové typ V

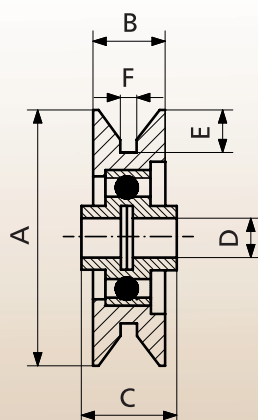

Kladky kovové typ W

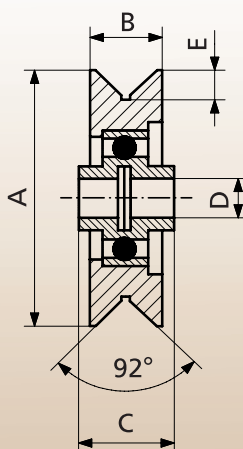

Kladky kovové typ U

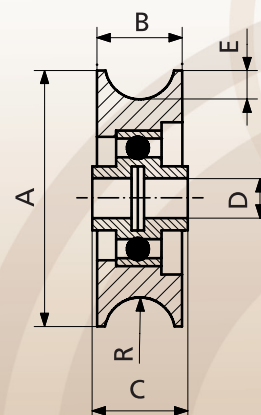



Kolečka litinová s nákolkem s kuličkovými ložisky

typ	mm	A	B	C	D	E	kg
96100.01	100	100	20	40	30	75	500
96125.01	125	125	20	52	34	100	800
96145.01	145	145	20	52	36	125	900
96160.01	160	160	20	60	46	136	1200
96180.01	180	180	25	60	48	150	1000
96240.01	240	240	35	60	48	200	1500

Kolečka litinová s nákolkem s drážkou pro pero

typ	mm	A	B	C	D	E	F	kg
96100.11	100	100	20	40	30	75	22,5	500
96125.11	125	125	20	52	34	100	22,5	800
96145.11	145	145	20	52	36	125	22,5	900
96160.11	160	160	20	60	46	136	22,5	1200
96180.11	180	180	25	60	48	150	27,9	1000
96240.11	240	240	35	60	48	200	38,3	1500

Kolečko s kuličkovými ložisky

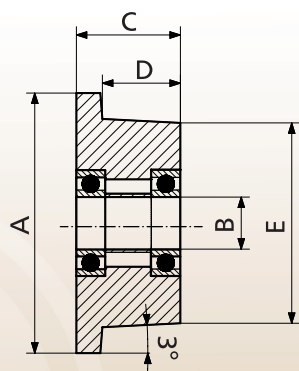

Kolečko s drážkou pro pero

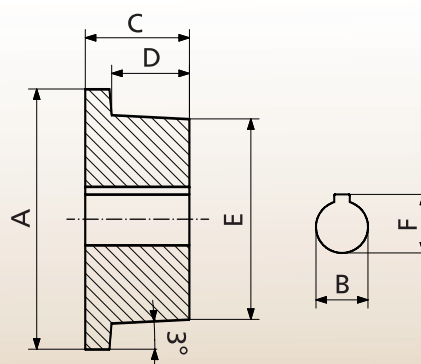

Lined area for notes with horizontal ruling lines.

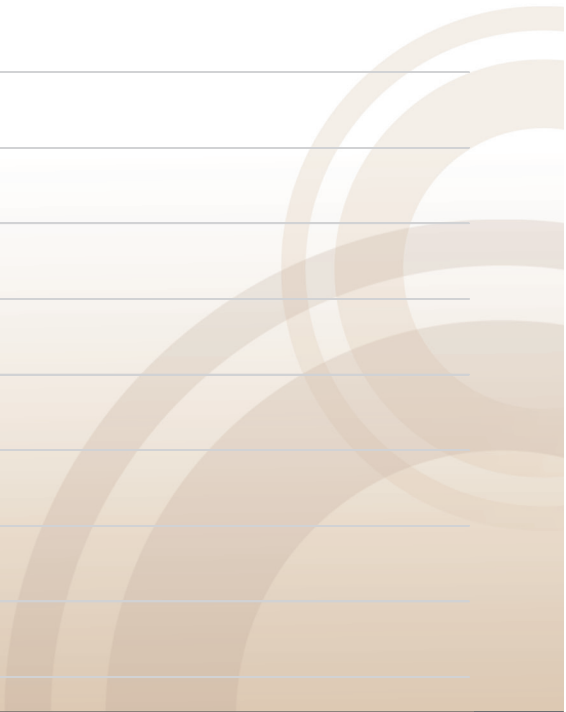

Středisko Fryšták

Petr Šiška - Cone Zlín
ul. Tovární

763 16 Fryšták

tel./fax: + 420 577 911 642

+ 420 577 911 645

mobtel.: + 420 739 457 221

e-mail: obchod@conezlin.cz (příjem objednávek)

info@conezlin.cz (ostatní pošta)



Váš obchodní partner



Středisko Dobrochov

Dobrochov 101

798 07

Brodek u Prostějova

tel./fax: + 420 582 335 257

mobtel.: + 420 733 531 780

e-mail: infod@conezlin.cz

